

Game Boy: Complete Technical Reference

gekkio
<https://gekkio.fi>

August 19, 2024

Revision 153



This work is licensed under a Creative Commons Attribution-ShareAlike 4.0 International License.

Preface

Caveat

IMPORTANT: This document focuses at the moment on 1st and 2nd generation devices (models before the Game Boy Color), and some hardware details are very different in later generations.

Be very careful if you make assumptions about later generation devices based on this document!

How to read this document

Speculation

This is something that hasn't been verified, but would make a lot of sense.

Caveat

This explains some caveat about this documentation that you should know.

Warning

This is a warning about something.

0.1 Formatting of numbers

When a single bit is discussed in isolation, the value looks like this: 0, 1.

Binary numbers are prefixed with `0b` like this: `0b0101101`, `0b11011`, `0b00000000`. Values are prefixed with zeroes when necessary, so the total number of digits always matches the number of digits in the value.

Hexadecimal numbers are prefixed with `0x` like this: `0x1234`, `0xDEADBEEF`, `0xFF04`. Values are prefixed with zeroes when necessary, so the total number of characters always matches the number of nibbles in the value.

Examples:

	4-bit	8-bit	16-bit
Binary	<code>0b0101</code>	<code>0b10100101</code>	<code>0b0000101010100101</code>
Hexadecimal	<code>0x5</code>	<code>0xA5</code>	<code>0x0AA5</code>

0.2 Register definitions

Register 0.1: 0x1234 - This is a hardware register definition

R/W-0	R/W-1	U-1	R-0	R-1	R-x	W-1	U-0
VALUE<1:0>			BIGVAL<7:5>			FLAG	
bit 7	6	5	4	3	2	1	bit 0

Top row legend:

- R** Bit can be read.
- W** Bit can be written. If the bit cannot be read, reading returns a constant value defined in the bit list of the register in question.
- U** Unimplemented bit. Writing has no effect, and reading returns a constant value defined in the bit list of the register in question.
- n** Value after system reset: 0, 1, or x.
- 1** Bit is set.
- 0** Bit is cleared.
- x** Bit is unknown (e.g. depends on external things such as user input)

Middle row legend:

VALUE<1:0>	Bits 1 and 0 of VALUE
	Unimplemented bit
BIGVAL<7:5>	Bits 7, 6, 5 of BIGVAL
FLAG	Single-bit value FLAG

In this example:

- After system reset, VALUE is 0b01, BIGVAL is either 0b010 or 0b011, FLAG is 0b1.
- Bits 5 and 0 are unimplemented. Bit 5 always returns 1, and bit 0 always returns 0.
- Both bits of VALUE can be read and written. When this register is written, bit 7 of the written value goes to bit 1 of VALUE.
- FLAG can only be written to, so reads return a value that is defined elsewhere.
- BIGVAL cannot be written to. Only bits 5-7 of BIGVAL are defined here, so look elsewhere for the low bits 0-4.

Contents

Preface	2
How to read this document	3
0.1 Formatting of numbers	3
0.2 Register definitions	4
Contents	5
I Game Boy console architecture	10
1 Introduction	11
2 Clocks	13
2.1 System clock	13
System clock frequency	13
2.2 Clock periods, T-cycles, and M-cycles	13
II Sharp SM83 CPU core	15
3 Introduction	16
3.1 History	16
4 Simple model	17
5 CPU core timing	18
5.1 Fetch/execute overlap	18
Fetch/execute overlap timing example	18
6 Sharp SM83 instruction set	20
6.1 Overview	20
CB opcode prefix	20
Undefined opcodes	20
6.2 8-bit load instructions	21
LD r, r': Load register (register)	21
LD r, n: Load register (immediate)	22
LD r, (HL): Load register (indirect HL)	23
LD (HL), r: Load from register (indirect HL)	24
LD (HL), n: Load from immediate data (indirect HL)	25
LD A, (BC): Load accumulator (indirect BC)	26
LD A, (DE): Load accumulator (indirect DE)	27
LD (BC), A: Load from accumulator (indirect BC)	28
LD (DE), A: Load from accumulator (indirect DE)	29
LD A, (nn): Load accumulator (direct)	30
LD (nn), A: Load from accumulator (direct)	31
LDH A, (C): Load accumulator (indirect 0xFF00+C)	32
LDH (C), A: Load from accumulator (indirect 0xFF00+n)	33
LDH A, (n): Load accumulator (direct 0xFF00+n)	34
LDH (n), A: Load from accumulator (direct 0xFF00+n)	35
LD A, (HL-): Load accumulator (indirect HL, decrement)	36
LD (HL-), A: Load from accumulator (indirect HL, decrement)	37
LD A, (HL+): Load accumulator (indirect HL, increment)	38
LD (HL+), A: Load from accumulator (indirect HL, increment)	39
6.3 16-bit load instructions	40

LD rr, nn: Load 16-bit register / register pair	40
LD (nn), SP: Load from stack pointer (direct)	41
LD SP, HL: Load stack pointer from HL	42
PUSH rr: Push to stack	43
POP rr: Pop from stack	44
LD HL, SP+e: Load HL from adjusted stack pointer	45
6.4 8-bit arithmetic and logical instructions	46
ADD r: Add (register)	46
ADD (HL): Add (indirect HL)	47
ADD n: Add (immediate)	48
ADC r: Add with carry (register)	49
ADC (HL): Add with carry (indirect HL)	50
ADC n: Add with carry (immediate)	51
SUB r: Subtract (register)	52
SUB (HL): Subtract (indirect HL)	53
SUB n: Subtract (immediate)	54
SBC r: Subtract with carry (register)	55
SBC (HL): Subtract with carry (indirect HL)	56
SBC n: Subtract with carry (immediate)	57
CP r: Compare (register)	58
CP (HL): Compare (indirect HL)	59
CP n: Compare (immediate)	60
INC r: Increment (register)	61
INC (HL): Increment (indirect HL)	62
DEC r: Decrement (register)	63
DEC (HL): Decrement (indirect HL)	64
AND r: Bitwise AND (register)	65
AND (HL): Bitwise AND (indirect HL)	66
AND n: Bitwise AND (immediate)	67
OR r: Bitwise OR (register)	68
OR (HL): Bitwise OR (indirect HL)	69
OR n: Bitwise OR (immediate)	70
XOR r: Bitwise XOR (register)	71
XOR (HL): Bitwise XOR (indirect HL)	72
XOR n: Bitwise XOR (immediate)	73
CCF: Complement carry flag	74
SCF: Set carry flag	75
DAA: Decimal adjust accumulator	76
CPL: Complement accumulator	77
6.5 16-bit arithmetic instructions	78
INC rr: Increment 16-bit register	78
DEC rr: Decrement 16-bit register	79
ADD HL, rr: Add (16-bit register)	80
ADD SP, e: Add to stack pointer (relative)	81
6.6 Rotate, shift, and bit operation instructions	83
RLCA: Rotate left circular (accumulator)	83
RRCA: Rotate right circular (accumulator)	84
RLA: Rotate left (accumulator)	85
RRA: Rotate right (accumulator)	86

RLC r: Rotate left circular (register)	87
RLC (HL): Rotate left circular (indirect HL)	88
RRC r: Rotate right circular (register)	89
RRC (HL): Rotate right circular (indirect HL)	90
RL r: Rotate left (register)	91
RL (HL): Rotate left (indirect HL)	92
RR r: Rotate right (register)	93
RR (HL): Rotate right (indirect HL)	94
SLA r: Shift left arithmetic (register)	95
SLA (HL): Shift left arithmetic (indirect HL)	96
SRA r: Shift right arithmetic (register)	97
SRA (HL): Shift right arithmetic (indirect HL)	98
SWAP r: Swap nibbles (register)	99
SWAP (HL): Swap nibbles (indirect HL)	100
SRL r: Shift right logical (register)	101
SRL (HL): Shift right logical (indirect HL)	102
BIT b, r: Test bit (register)	103
BIT b, (HL): Test bit (indirect HL)	104
RES b, r: Reset bit (register)	105
RES b, (HL): Reset bit (indirect HL)	106
SET b, r: Set bit (register)	107
SET b, (HL): Set bit (indirect HL)	108
6.7 Control flow instructions	110
JP nn: Jump	110
JP HL: Jump to HL	111
JP cc, nn: Jump (conditional)	112
JR e: Relative jump	114
JR cc, e: Relative jump (conditional)	115
CALL nn: Call function	117
CALL cc, nn: Call function (conditional)	118
RET: Return from function	120
RET cc: Return from function (conditional)	121
RETI: Return from interrupt handler	122
RST n: Restart / Call function (implied)	123
6.8 Miscellaneous instructions	124
HALT: Halt system clock	124
STOP: Stop system and main clocks	124
DI: Disable interrupts	124
EI: Enable interrupts	125
NOP: No operation	126

III Game Boy SoC peripherals and features **127**

7 Boot ROM **129**

7.1 Boot ROM types	129
DMG boot ROM	130
MGB boot ROM	130
SGB boot ROM	130
SGB2 boot ROM	130

Early DMG boot ROM (“DMG0”)	130
8 DMA (Direct Memory Access)	131
8.1 Object Attribute Memory (OAM) DMA	131
OAM DMA address decoding	132
OAM DMA transfer timing	132
OAM DMA bus conflicts	132
9 PPU (Picture Processing Unit)	133
10 Port P1 (Joypad, Super Game Boy communication)	134
11 Serial communication	135
IV Game Boy game cartridges	136
12 MBC1 mapper chip	137
12.1 MBC1 registers	137
12.2 ROM in the 0x0000–0x7FFF area	139
ROM banking example 1	139
ROM banking example 2	140
12.3 RAM in the 0xA000–0xBFFF area	140
RAM banking example 1	140
12.4 MBC1 multicarts (“MBC1M”)	141
ROM banking example 1	141
Detecting multicarts	141
12.5 Dumping MBC1 carts	142
13 MBC2 mapper chip	143
13.1 MBC2 registers	143
13.2 ROM in the 0x0000–0x7FFF area	144
13.3 RAM in the 0xA000–0xBFFF area	144
13.4 Dumping MBC2 carts	145
14 MBC3 mapper chip	146
15 MBC30 mapper chip	147
16 MBC5 mapper chip	148
16.1 MBC5 registers	148
17 MBC6 mapper chip	150
18 MBC7	151
19 HuC-1 mapper chip	152
20 HuC-3 mapper chip	153
21 MMM01	154
22 TAMA5	155
Appendices	156
A Instruction set tables	157
B Memory map tables	160
C Game Boy external bus	165
C.1 Bus timings	165
D Chip pinouts	167
D.1 CPU chips	167
D.2 Cartridge chips	167
Bibliography	168

Part I

Game Boy console architecture

Chapter 1

Introduction

The original Game Boy and its successors were the most popular and financially successful handheld consoles in the 1990s and early 2000s with several millions units sold and a large catalogue of officially published games. Unlike many older consoles, Game Boys use only a single integrated System-on-a-Chip (SoC) for almost everything, and this SoC includes the processor (CPU) core, some memories, and various peripherals.

Caveat

The Game Boy SoC is sometimes called the “CPU”, even though it has a large amount of other peripherals as well. For example, the Game Boy Pocket SoC literally has the text “CPU MGB” on it, even though the CPU core takes only a small fraction of the entire chip area. This terminology is therefore misleading, and is like calling a computer motherboard and all connected expansion cards and storage devices the “CPU”.

This document always makes a clear distinction between the entire chip (SoC) and the processor inside it (the CPU *core*).

Most Game Boy consoles are handhelds, starting from the original Game Boy in 1989, ending with the Game Boy Micro in 2005. In addition to handheld devices, Game Boy SoCs are also used in some accessories meant for other consoles, such as the Super Game Boy for the SNES/SFC.

Game Boy consoles and their SoCs can be categorized based on three supported technical architectures:

- GB: the original Game Boy architecture with a Sharp SM83 CPU core and 4-level grayscale graphics
- GBC: a mostly backwards compatible extension to the GB architecture that adds color graphics and small improvements
- GBA: a completely different architecture based on the ARM processor instruction set and a completely redesigned set of peripherals. **This document does not cover GBA architecture, because it has little in common with GB/GBC.** GBA-based consoles and chips are only mentioned for their backwards compatibility with GB/GBC architectures.

Table 1.1 lists all officially released Game Boy consoles, including handhelds and accessories for other consoles. Every model has an internal codename, such as original Game Boy’s codename Dot Matrix Game (DMG), that is also present on the mainboard.

i **Caveat**

This document refers to different console models usually by their unique codename to prevent confusion. For example, using the abbreviation GBP could refer to either Game Boy Pocket or Game Boy Player, but there's no confusion when MGB and GBS are used instead.

In this document GBC refers to the technical architecture, while CGB refers to Game Boy Color consoles specifically. Likewise, GBA refers to the architecture and AGB to exactly one console model.

Console name	Codename	SoC type	GB	GBC	GBA
<i>Handhelds</i>					
Game Boy	DMG	DMG-CPU	✓		
Game Boy Pocket	MGB	CPU MGB	✓		
Game Boy Light	MGL	CPU MGB	✓		
Game Boy Color	CGB	CPU CGB	✓	✓	
Game Boy Advance	AGB	CPU AGB	✓	✓	✓
Game Boy Advance SP	AGS	CPU AGB	✓	✓	✓
Game Boy Micro	OXY	CPU AGB			✓
<i>Accessories</i>					
Super Game Boy	SGB	SGB-CPU	✓		
Super Game Boy 2	SGB2	CPU SGB2	✓		
Game Boy Player	GBS	CPU AGB	✓	✓	✓

Table 1.1: Summary of Game Boy consoles

Chapter 2

Clocks

2.1 System clock

The system oscillator is the primary clock source in a Game Boy system, and it generates the **system clock**. Almost all other clocks are derived from the system clock using prescalers / clock dividers, but there are some exceptions:

- If a Game Boy is set up to do a serial transfer in secondary mode, the serial data register is directly clocked using the serial clock signal coming from the link port. Two Game Boys connected with a link cable never have precisely the same clock phase and frequency relative to each other, so the serial clock of the primary side has no direct relation to the system clock of the secondary side.
- The inserted game cartridge may use other clock(s) internally. A typical example in some official games is the Real Time Clock (RTC), which is based on a 32.768 kHz oscillator and a clock-domain crossing circuit so that RTC data can be read using the cartridge bus while the RTC circuit is ticking independently using its own clock.

The Game Boy SoC uses two pins for the system oscillator: XI and XO. These pins along with some external components can be used form a Pierce oscillator circuit. Alternatively, the XI pin can be driven directly with a clock signal originating from somewhere else, and the XO pin can be left unconnected.

System clock frequency

In DMG and MGB consoles the system oscillator circuit uses an external quartz crystal with a nominal frequency of **4.194304 MHz** ($= 2^{22}$ MHz = 4 MiHz) to form a Pierce oscillator circuit. This frequency is considered to be the standard frequency of a Game Boy.

In SGB the system oscillator input is directly driven by the ICD2 chip on the SGB cartridge. The clock is derived via /5 division of the main SNES / SFC clock, which has a different frequency depending on the console region (21.447 MHz NTSC, 21.281 MHz PAL). The SNES / SFC clock does not divide into 4.194304 MHz with integer division, so the clock seen by the SGB SoC is not the same as in DMG and MGB consoles. The frequency is higher, so everything is sped up by a small amount and audio has a slightly higher pitch.

In SGB2, just like SGB, the system oscillator input is driven by the ICD2 chip, but instead of using the SNES / SFC clock, the ICD2 chip is driven by a Pierce oscillator circuit with a 20.971520 MHz crystal. ICD2 then divides this frequency by /5 to obtain the final frequency seen by the SGB2 SoC, which is 4.194304 MHz that matches the standard DMG / MGB frequency.

2.2 Clock periods, T-cycles, and M-cycles

In digital logic, a clock switches between low and high states and every transition happens on a *clock edge*, which might be a rising edge (low → high transition) or a falling edge (high → low transition). A single *clock period* is measured between two edges of the same type, so that the clock goes through two opposing edges and returns to its original state after the clock period. The typical convention is that a clock period consists of a rising edge and a falling edge.

In addition to the system clock and other clocks derived from it, Game Boy systems also use *inverted clocks* in some peripherals, which means the rising edge of an inverted clock may happen at the same time as a falling edge of the original clock. Figure 2.1 shows two clock periods of the system clock and an inverted clock derived from it, and how they are out of phase due to clock inversion.

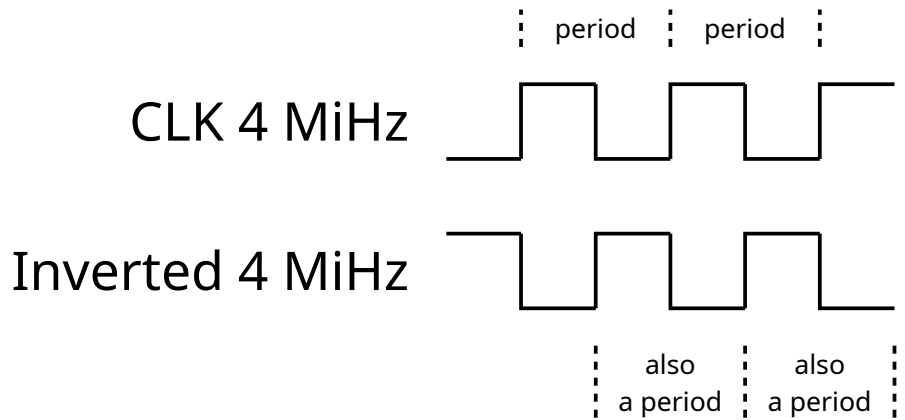

Figure 2.1: Example clock periods

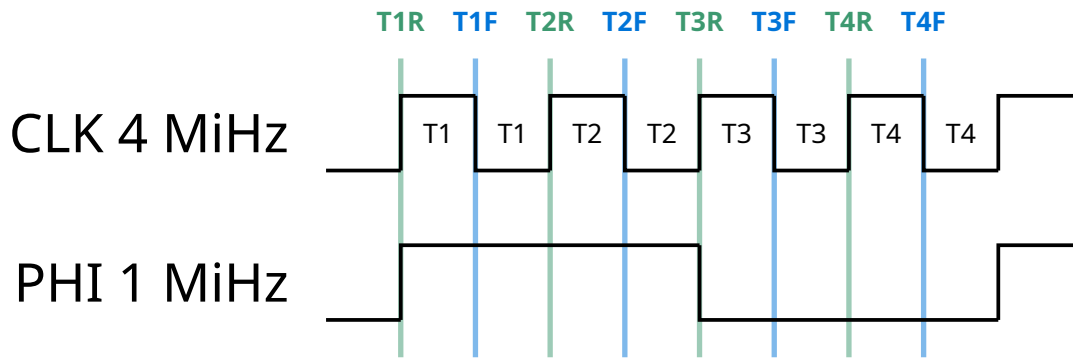

Figure 2.2: Clock edges in a machine cycle

Part II
Sharp SM83 CPU core

Chapter 3

Introduction

The CPU core in the Game Boy SoC is a custom Sharp design that hasn't publicly been given a name by either Sharp or Nintendo. However, using old Sharp datasheets and databooks as evidence, the core has been identified to be a Sharp **SM83** CPU core, or at least something that is 100% compatible with it. SM83 is a custom CPU core used in some custom Application Specific Integrated Chips (ASICs) manufactured by Sharp in the 1980s and 1990s.

Warning

Some sources claim Game Boy uses a "modified" Zilog Z80 or Intel 8080 CPU core. While the SM83 resembles both and has many identical instructions, it can't execute all Z80/8080 programs, and finer details such as timing of instructions often differ.

SM83 is an 8-bit CPU core with a 16-bit address bus. The Instruction Set Architecture (ISA) is based on both Z80 and 8080, and is close enough to Z80 that programmers familiar with Z80 assembly can quickly become productive with SM83 as well. Some Z80 programs may also work directly on SM83, assuming only opcodes supported by both are used and the program is not sensitive to timing differences.

Speculation

Sharp most likely designed SM83 to closely resemble Z80, so it would be easy for programmers already familiar with the widely popular Z80 to write programs for it. However, SM83 is not a "modified Z80" because the internal implementation is completely different. At the time Sharp also manufactured real Z80 chips such as LH0080 under a license from Zilog, so they were familiar with Z80 internals but did not directly copy the actual implementation of the CPU core. If you compare photos of a decapped Z80 chip and a GB SoC, you will see two very different-looking CPU cores.

3.1 History

The first known mention of the SM83 CPU core is in Sharp Microcomputers Data Book (1990), where it is listed as the CPU core used in the SM8320 8-bit microcomputer chip, intended for inverter air conditioners [1]. The data book describes some details of the CPU core, such as a high-level overview of the supported instructions, but precise details such as full opcode tables are not included. Another CPU core called SM82 is also mentioned, but based on the details it's clearly a completely different one.

The SM83 CPU core later appeared in Sharp Microcomputer Data Book (1996), where it is listed as the CPU core in the SM8311/SM8313/SM8314/SM8315 8-bit microcomputer chips, meant for home appliances [2]. This data book describes the CPU core in much more detailed manner, and other than some mistakes in the descriptions, the details seem to match what is known about the GB SoC CPU core from other sources.

Chapter 4

Simple model

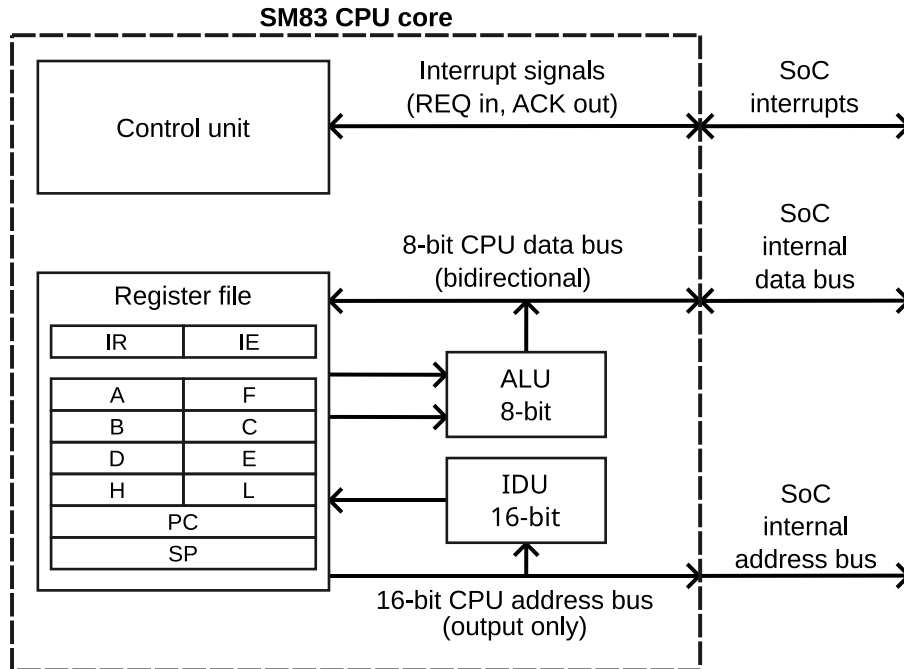

Figure 4.3: Simple model of the SM83 CPU core

Figure 4.3 shows a simplified model of the SM83 CPU core. The core interacts with the rest of the SoC using interrupt signals, an 8-bit bidirectional data bus, and a 16-bit address bus controlled by the CPU core.

The main subsystems of the CPU core are as follows:

Control unit The control unit decodes the executed instructions and generates control signals for the rest of the CPU core. It is also responsible for checking and dispatching interrupts.

Register file The register file holds most of the state of the CPU inside registers. It contains the 16-bit Program Counter (PC), the 16-bit Stack Pointer (SP), the 8-bit Accumulator (A), the Flags register (F), general-purpose register pairs consisting of two 8-bit halves such as BC, DE, HL, and the special-purpose 8-bit registers Instruction Register (IR) and Interrupt Enable (IE).

ALU An 8-bit Arithmetic Logic Unit (ALU) has two 8-bit input ports and is capable of performing various calculations. The ALU outputs its result either to the register file or the CPU data bus.

IDU A dedicated 16-bit Increment/Decrement Unit (IDU) is capable of performing only simple increment/decrement operations on the 16-bit address bus value, but they can be performed independently of the ALU, improving maximum performance of the CPU core. The IDU always outputs its result back to the register file, where it can be written to a register pair or a 16-bit register.

Chapter 5

CPU core timing

5.1 Fetch/execute overlap

Sharp SM83 uses a microprocessor design technique known as *fetch/execute overlap* to improve CPU performance by doing opcode fetches in parallel with instruction execution whenever possible. Since the CPU can only perform one memory access per M-cycle, it is worth it to try to do memory operations as soon as possible. Also, when doing a memory read, the CPU cannot use the data during the same M-cycle so the true minimum effective duration of instructions is 2 machine cycles, not 1 machine cycle.

Every instruction needs one machine cycle for the fetch stage, and at least one machine cycle for the decode/execute stage. However, the fetch stage of an instruction always overlaps with the last machine cycle of the execute stage of the previous instruction. The overlapping execute stage cycle may still do some work (e.g. ALU operation and/or register writeback) but memory access is reserved for the fetch stage of the next instruction.

Since all instructions effectively last one machine cycle longer, fetch/execute overlap is usually ignored in documentation intended for programmers. It is much easier to think of a program as a sequence of non-overlapping instructions and consider only the execute stages when calculating instruction durations. However, when emulating a SM83 CPU core, understanding and emulating the overlap can be useful.

Warning

Sharp SM831x is a family of single-chip SoCs from Sharp that use the SM83 CPU core, and their datasheet [3] includes a description of fetch/execute overlap. However, the description is not completely correct and can in fact be misleading.

For example, the timing diagram includes an instruction that does not involve opcode fetch at all, and memory operations for two instructions are shown to happen at the same time, which is not possible.

Fetch/execute overlap timing example

Let's assume the CPU is executing a program that starts from the address `0x1000` and contains the following instructions:

<code>0x1000</code>	INC A
<code>0x1001</code>	LDH (n), A
<code>0x1003</code>	RST 0x08
<code>0x0008</code>	NOP

The following timing diagram shows all memory operations done by the CPU, and the fetch and execute stages of each instruction:

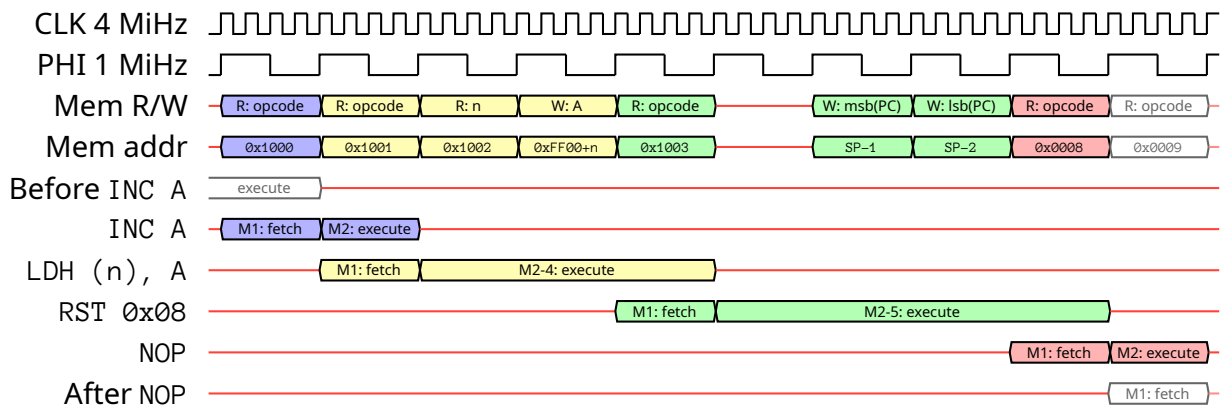

Figure 5.4: Fetch/execute overlap example

Chapter 6

Sharp SM83 instruction set

6.1 Overview

CB opcode prefix

Undefined opcodes

6.2 8-bit load instructions

LD r, r': Load register (register)

Load to the 8-bit register r , data from the 8-bit register r' .

Opcode $0b01xxxxyyy$ /various

Duration 1 machine cycle

Length 1 byte: opcode

Flags -

Simple timing and pseudocode

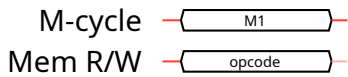

```
opcode = read_memory(addr=PC); PC = PC + 1
```

```
if opcode == 0x41: # example: LD B, C
```

```
  B = C
```

Detailed timing and pseudocode

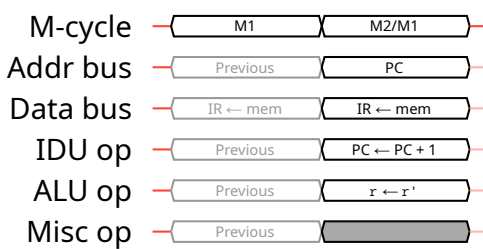

```
# M2/M1
```

```
if IR == 0x41: # example: LD B, C
```

```
  IR, intr = fetch_cycle(addr=PC); PC = PC + 1; B = C
```

LD r, n: Load register (immediate)

Load to the 8-bit register r , the immediate data n .

Opcode `0b00xxx110`/various

Duration 2 machine cycles

Length 2 bytes: opcode + n

Flags -

Simple timing and pseudocode

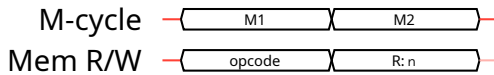

```
opcode = read_memory(addr=PC); PC = PC + 1  
if opcode == 0x06: # example: LD B, n  
    B = read_memory(addr=PC); PC = PC + 1
```

Detailed timing and pseudocode

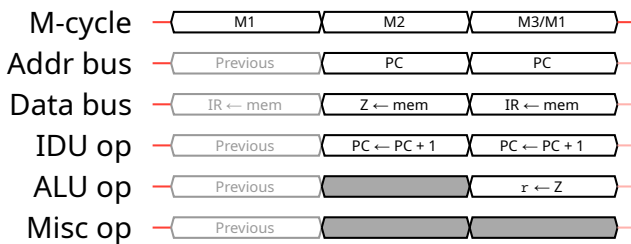

```
# M2  
if IR == 0x06: # example: LD B, n  
    Z = read_memory(addr=PC); PC = PC + 1  
# M3/M1  
IR, intr = fetch_cycle(addr=PC); PC = PC + 1; B = Z
```

LD r, (HL): Load register (indirect HL)

Load to the 8-bit register r , data from the absolute address specified by the 16-bit register HL.

Opcode $0b01xxx110$ /various

Duration 2 machine cycles

Length 1 byte: opcode

Flags -

Simple timing and pseudocode

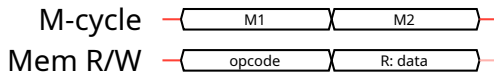

```
opcode = read_memory(addr=PC); PC = PC + 1  
if opcode == 0x46: # example: LD B, (HL)  
    B = read_memory(addr=HL)
```

Detailed timing and pseudocode

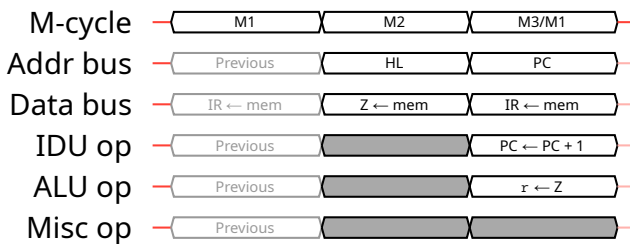

```
# M2  
if IR == 0x46: # example: LD B, (HL)  
    Z = read_memory(addr=HL)  
# M3/M1  
IR, intr = fetch_cycle(addr=PC); PC = PC + 1; B = Z
```

LD (HL), r: Load from register (indirect HL)

Load to the absolute address specified by the 16-bit register HL, data from the 8-bit register r.

Opcode 0b01110xxx/various

Duration 2 machine cycles

Length 1 byte: opcode

Flags -

Simple timing and pseudocode

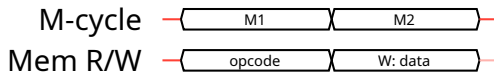

```
opcode = read_memory(addr=PC); PC = PC + 1  
if opcode == 0x70: # example: LD (HL), B  
    write_memory(addr=HL, data=B)
```

Detailed timing and pseudocode

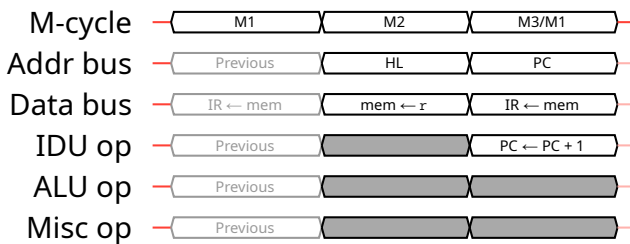

```
# M2  
if IR == 0x70: # example: LD (HL), B  
    write_memory(addr=HL, data=B)  
# M3/M1  
IR, intr = fetch_cycle(addr=PC); PC = PC + 1
```

LD (HL), n: Load from immediate data (indirect HL)

Load to the absolute address specified by the 16-bit register HL, the immediate data n.

Opcode 0b00110110/0x36

Duration 3 machine cycles

Length 2 bytes: opcode + n

Flags -

Simple timing and pseudocode

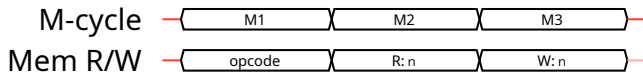

```
opcode = read_memory(addr=PC); PC = PC + 1
```

```
if opcode == 0x36:
```

```
    n = read_memory(addr=PC); PC = PC + 1
```

```
    write_memory(addr=HL, data=n)
```

Detailed timing and pseudocode

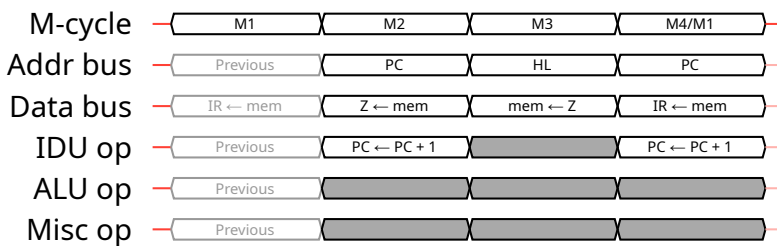

```
# M2
```

```
if IR == 0x36:
```

```
    Z = read_memory(addr=PC); PC = PC + 1
```

```
    # M3
```

```
    write_memory(addr=HL, data=Z)
```

```
    # M4/M1
```

```
    IR, intr = fetch_cycle(addr=PC); PC = PC + 1
```

LD A, (BC): Load accumulator (indirect BC)

Load to the 8-bit A register, data from the absolute address specified by the 16-bit register BC.

Opcode 0b00001010/0x0A

Duration 2 machine cycles

Length 1 byte: opcode

Flags -

Simple timing and pseudocode

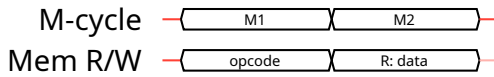

```
opcode = read_memory(addr=PC); PC = PC + 1  
if opcode == 0x0A:  
    A = read_memory(addr=BC)
```

Detailed timing and pseudocode

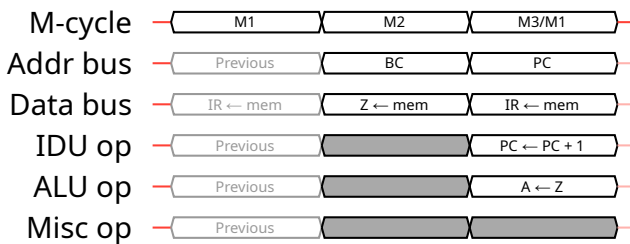

```
# M2  
if IR == 0x0A:  
    Z = read_memory(addr=BC)  
# M3/M1  
IR, intr = fetch_cycle(addr=PC); PC = PC + 1; A = Z
```

LD A, (DE): Load accumulator (indirect DE)

Load to the 8-bit A register, data from the absolute address specified by the 16-bit register DE.

Opcode 0b00011010/0x1A

Duration 2 machine cycles

Length 1 byte: opcode

Flags -

Simple timing and pseudocode

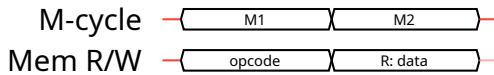

```
opcode = read_memory(addr=PC); PC = PC + 1  
if opcode == 0x1A:  
    A = read_memory(addr=DE)
```

Detailed timing and pseudocode

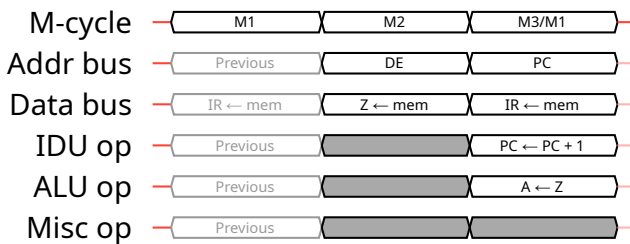

```
# M2  
if IR == 0x1A:  
    Z = read_memory(addr=DE)  
# M3/M1  
IR, intr = fetch_cycle(addr=PC); PC = PC + 1; A = Z
```

LD (BC, A: Load from accumulator (indirect BC))

Load to the absolute address specified by the 16-bit register BC, data from the 8-bit A register.

Opcode 0b00000010/0x02

Duration 2 machine cycles

Length 1 byte: opcode

Flags -

Simple timing and pseudocode

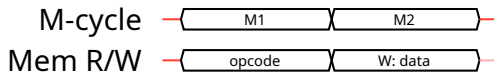

```
opcode = read_memory(addr=PC); PC = PC + 1  
if opcode == 0x02:  
    write_memory(addr=BC, data=A)
```

Detailed timing and pseudocode

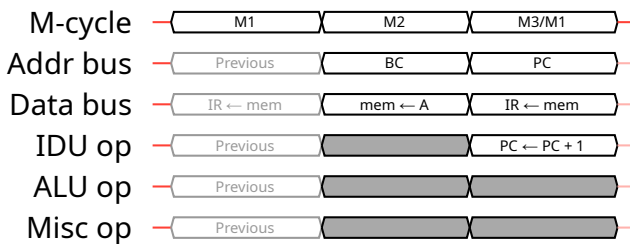

```
# M2  
if IR == 0x02:  
    write_memory(addr=BC, data=A)  
# M3/M1  
IR, intr = fetch_cycle(addr=PC); PC = PC + 1
```

LD (DE), A: Load from accumulator (indirect DE)

Load to the absolute address specified by the 16-bit register DE, data from the 8-bit A register.

Opcode 0b00010010/0x12

Duration 2 machine cycles

Length 1 byte: opcode

Flags -

Simple timing and pseudocode

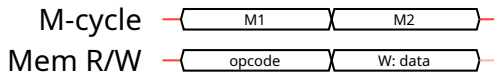

```
opcode = read_memory(addr=PC); PC = PC + 1  
if opcode == 0x12:  
    write_memory(addr=DE, data=A)
```

Detailed timing and pseudocode

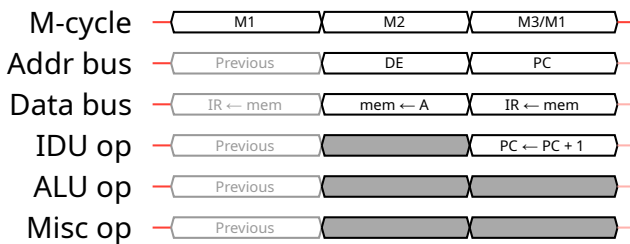

```
# M2  
if IR == 0x12:  
    write_memory(addr=DE, data=A)  
# M3/M1  
IR, intr = fetch_cycle(addr=PC); PC = PC + 1
```

LD A, (nn): Load accumulator (direct)

Load to the 8-bit A register, data from the absolute address specified by the 16-bit operand nn.

Opcode 0b11111010/0xFA

Duration 4 machine cycles

Length 3 bytes: opcode + LSB(nn) + MSB(nn) **Flags** -

Simple timing and pseudocode

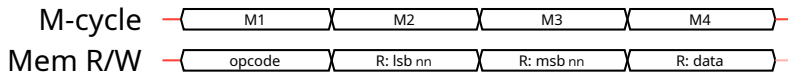

```
opcode = read_memory(addr=PC); PC = PC + 1
```

```
if opcode == 0xFA:
```

```
    nn_lsb = read_memory(addr=PC); PC = PC + 1
```

```
    nn_msb = read_memory(addr=PC); PC = PC + 1
```

```
    nn = unsigned_16(lsb=nn_lsb, msb=nn_msb)
```

```
    A = read_memory(addr=nn)
```

Detailed timing and pseudocode

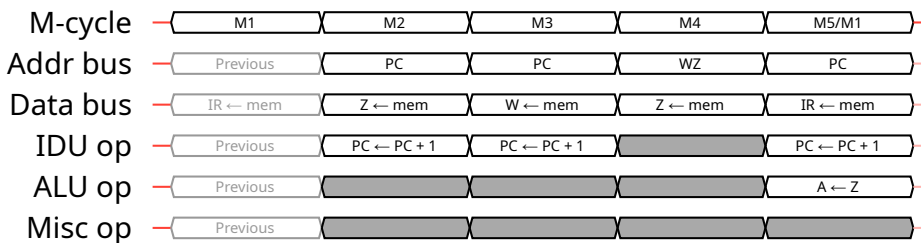

```
# M2
```

```
if IR == 0xFA:
```

```
    Z = read_memory(addr=PC); PC = PC + 1
```

```
# M3
```

```
    W = read_memory(addr=PC); PC = PC + 1
```

```
# M4
```

```
    Z = read_memory(addr=WZ)
```

```
# M5/M1
```

```
    IR, intr = fetch_cycle(addr=PC); PC = PC + 1; A = Z
```

LD (nn), A: Load from accumulator (direct)

Load to the absolute address specified by the 16-bit operand nn, data from the 8-bit A register.

Opcode 0b111101010/0xEA

Duration 4 machine cycles

Length 3 bytes: opcode + LSB(nn) + MSB(nn) **Flags** -

Simple timing and pseudocode

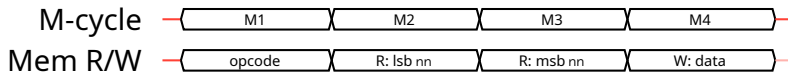

```
opcode = read_memory(addr=PC); PC = PC + 1
```

```
if opcode == 0xEA:
```

```
    nn_lsb = read_memory(addr=PC); PC = PC + 1
```

```
    nn_msb = read_memory(addr=PC); PC = PC + 1
```

```
    nn = unsigned_16(lsb=nn_lsb, msb=nn_msb)
```

```
    write_memory(addr=nn, data=A)
```

Detailed timing and pseudocode

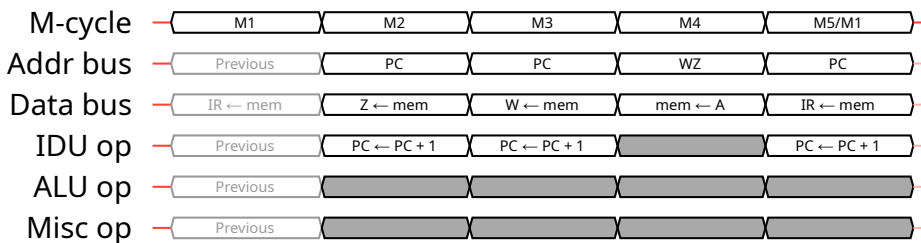

```
# M2
```

```
if IR == 0xEA:
```

```
    Z = read_memory(addr=PC); PC = PC + 1
```

```
# M3
```

```
    W = read_memory(addr=PC); PC = PC + 1
```

```
# M4
```

```
    write_memory(addr=WZ, data=A)
```

```
# M5/M1
```

```
    IR, intr = fetch_cycle(addr=PC); PC = PC + 1
```

LDH A, (C): Load accumulator (indirect 0xFF00+C)

Load to the 8-bit A register, data from the address specified by the 8-bit C register. The full 16-bit absolute address is obtained by setting the most significant byte to 0xFF and the least significant byte to the value of C, so the possible range is 0xFF00–0xFFFF.

Opcode 0b11110010/0xF2

Duration 2 machine cycles

Length 1 byte: opcode

Flags -

Simple timing and pseudocode

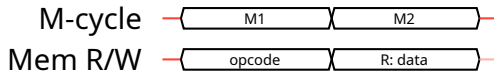

```
opcode = read_memory(addr=PC); PC = PC + 1  
if opcode == 0xF2:  
    A = read_memory(addr=unsigned_16(lsb=C, msb=0xFF))
```

Detailed timing and pseudocode

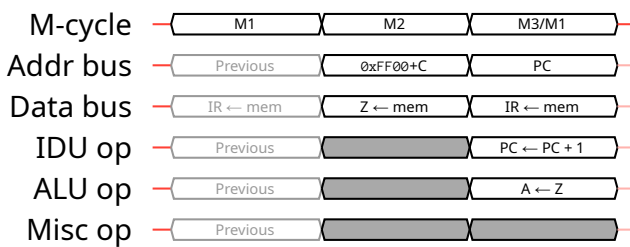

```
# M2  
if IR == 0xF2:  
    Z = read_memory(addr=unsigned_16(lsb=C, msb=0xFF))  
# M3/M1  
IR, intr = fetch_cycle(addr=PC); PC = PC + 1; A = Z
```

LDH (C), A: Load from accumulator (indirect 0xFF00+C)

Load to the address specified by the 8-bit C register, data from the 8-bit A register. The full 16-bit absolute address is obtained by setting the most significant byte to 0xFF and the least significant byte to the value of C, so the possible range is 0xFF00–0xFFFF.

Opcode 0b11100010/0xE2

Duration 2 machine cycles

Length 1 byte: opcode

Flags -

Simple timing and pseudocode

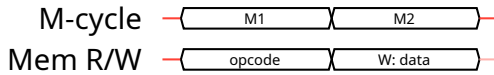

```
opcode = read_memory(addr=PC); PC = PC + 1  
if opcode == 0xE2:  
    write_memory(addr=unsigned_16(1sb=C, data=msb=0xFF), data=A)
```

Detailed timing and pseudocode

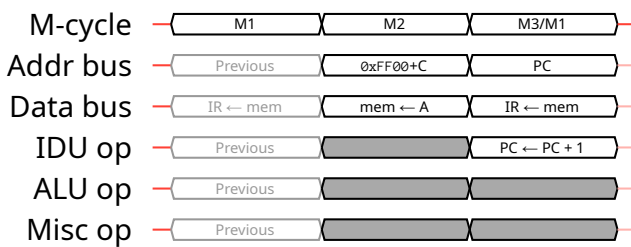

```
# M2  
if IR == 0xE2:  
    write_memory(addr=unsigned_16(1sb=C, data=msb=0xFF), data=A)  
# M3/M1  
IR, intr = fetch_cycle(addr=PC); PC = PC + 1
```

LDH A, (n): Load accumulator (direct 0xFF00+n)

Load to the 8-bit A register, data from the address specified by the 8-bit immediate data n. The full 16-bit absolute address is obtained by setting the most significant byte to 0xFF and the least significant byte to the value of n, so the possible range is 0xFF00–0xFFFF.

Opcode 0b11110000/0xF0

Duration 3 machine cycles

Length 2 bytes: opcode + n

Flags -

Simple timing and pseudocode

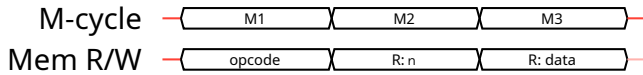

```
opcode = read_memory(addr=PC); PC = PC + 1
if opcode == 0xF0:
    n = read_memory(addr=PC); PC = PC + 1
    A = read_memory(addr=unsigned_16(lsb=n, msb=0xFF))
```

Detailed timing and pseudocode

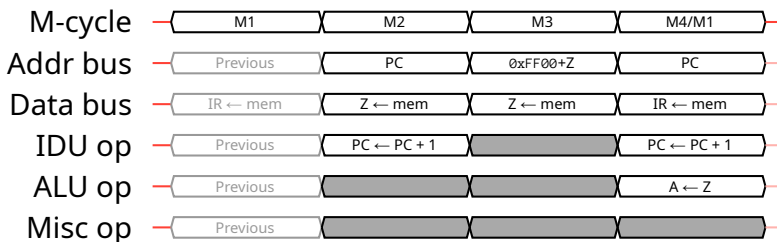

```
# M2
if IR == 0xF0:
    Z = read_memory(addr=PC); PC = PC + 1
# M3
Z = read_memory(addr=unsigned_16(lsb=Z, msb=0xFF))
# M4/M1
IR, intr = fetch_cycle(addr=PC); PC = PC + 1; A = Z
```

LDH (n), A: Load from accumulator (direct 0xFF00+n)

Load to the address specified by the 8-bit immediate data n, data from the 8-bit A register. The full 16-bit absolute address is obtained by setting the most significant byte to 0xFF and the least significant byte to the value of n, so the possible range is 0xFF00-0xFFFF.

Opcode 0b11100000/0xE0

Duration 3 machine cycles

Length 2 bytes: opcode + n

Flags -

Simple timing and pseudocode

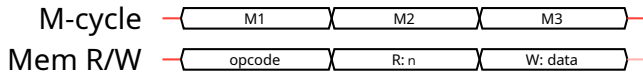

```
opcode = read_memory(addr=PC); PC = PC + 1
if opcode == 0xE0:
    n = read_memory(addr=PC); PC = PC + 1
    write_memory(addr=unsigned_16(lsb=n, msb=0xFF), data=A)
```

Detailed timing and pseudocode

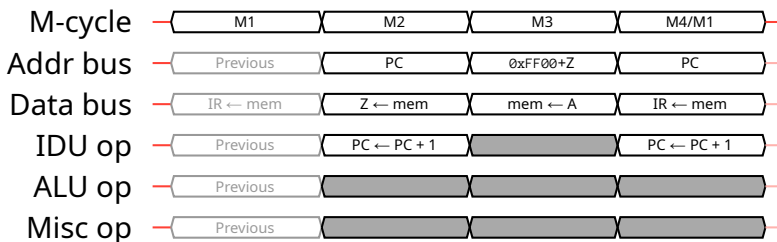

```
# M2
if IR == 0xE0:
    Z = read_memory(addr=PC); PC = PC + 1
# M3
write_memory(addr=unsigned_16(lsb=Z, msb=0xFF), data=A)
# M4/M1
IR, intr = fetch_cycle(addr=PC); PC = PC + 1
```

LD A, (HL-): Load accumulator (indirect HL, decrement)

Load to the 8-bit A register, data from the absolute address specified by the 16-bit register HL. The value of HL is decremented after the memory read.

Opcode 0b00111010/0x3A

Duration 2 machine cycles

Length 1 byte: opcode

Flags -

Simple timing and pseudocode

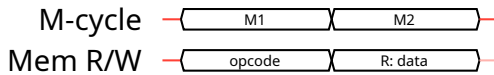

```
opcode = read_memory(addr=PC); PC = PC + 1
```

```
if opcode == 0x3A:
```

```
    A = read_memory(addr=HL); HL = HL - 1
```

Detailed timing and pseudocode

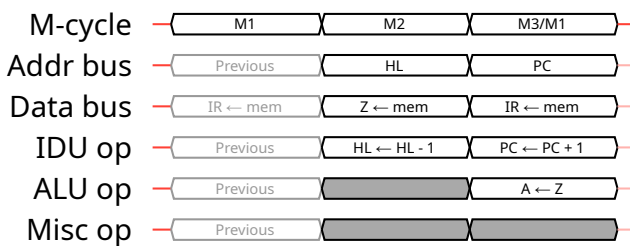

```
# M2
```

```
if IR == 0x3A:
```

```
    Z = read_memory(addr=HL); HL = HL - 1
```

```
# M3/M1
```

```
    IR, intr = fetch_cycle(addr=PC); PC = PC + 1; A = Z
```

LD (HL-), A: Load from accumulator (indirect HL, decrement)

Load to the absolute address specified by the 16-bit register HL, data from the 8-bit A register. The value of HL is decremented after the memory write.

Opcode 0b00110010/0x32

Duration 2 machine cycles

Length 1 byte: opcode

Flags -

Simple timing and pseudocode

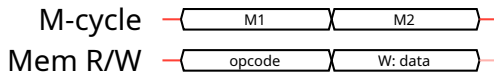

```
opcode = read_memory(addr=PC); PC = PC + 1  
if opcode == 0x32:  
    write_memory(addr=HL, data=A); HL = HL - 1
```

Detailed timing and pseudocode

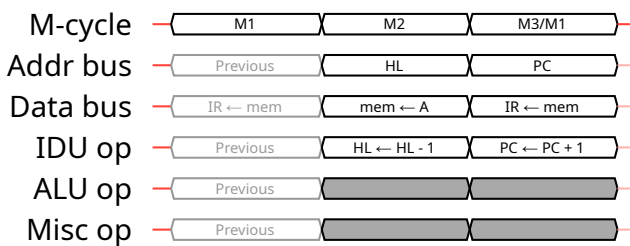

```
# M2  
if IR == 0x32:  
    write_memory(addr=HL, data=A); HL = HL - 1  
# M3/M1  
IR, intr = fetch_cycle(addr=PC); PC = PC + 1
```

LD A, (HL+): Load accumulator (indirect HL, increment)

Load to the 8-bit A register, data from the absolute address specified by the 16-bit register HL. The value of HL is incremented after the memory read.

Opcode 0b00101010/0x2A

Duration 2 machine cycles

Length 1 byte: opcode

Flags -

Simple timing and pseudocode

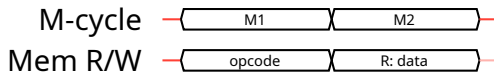

```
opcode = read_memory(addr=PC); PC = PC + 1
```

```
if opcode == 0x2A:
```

```
    A = read_memory(addr=HL); HL = HL + 1
```

Detailed timing and pseudocode

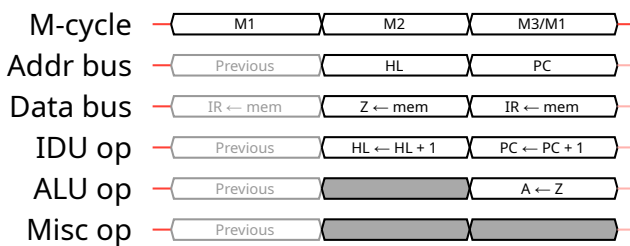

```
# M2
```

```
if IR == 0x2A:
```

```
    Z = read_memory(addr=HL); HL = HL + 1
```

```
# M3/M1
```

```
    IR, intr = fetch_cycle(addr=PC); PC = PC + 1; A = Z
```

LD (HL+), A: Load from accumulator (indirect HL, increment)

Load to the absolute address specified by the 16-bit register HL, data from the 8-bit A register. The value of HL is decremented after the memory write.

Opcode 0b00100010/0x22

Duration 2 machine cycles

Length 1 byte: opcode

Flags -

Simple timing and pseudocode

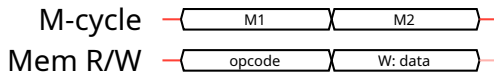

```
opcode = read_memory(addr=PC); PC = PC + 1
```

```
if opcode == 0x22:
```

```
    write_memory(addr=HL, data=A); HL = HL + 1
```

Detailed timing and pseudocode

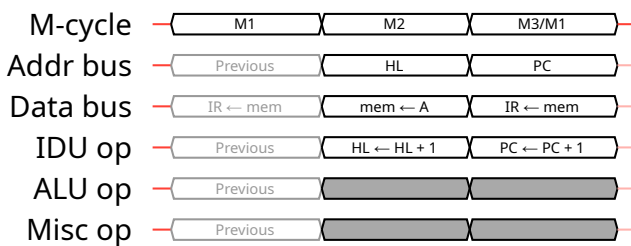

```
# M2
```

```
if IR == 0x22:
```

```
    write_memory(addr=HL, data=A); HL = HL + 1
```

```
# M3/M1
```

```
IR, intr = fetch_cycle(addr=PC); PC = PC + 1
```

6.3 16-bit load instructions

LD rr, nn: Load 16-bit register / register pair

Load to the 16-bit register `rr`, the immediate 16-bit data `nn`.

Opcode `0b00xx0001`/various **Duration** 3 machine cycles

Length 3 bytes: opcode + LSB(nn) + MSB(nn) **Flags** -

Simple timing and pseudocode

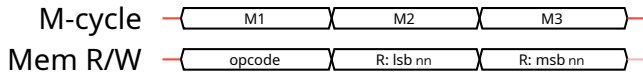

```
opcode = read_memory(addr=PC); PC = PC + 1
if opcode == 0x01: # example: LD BC, nn
    nn_lsb = read_memory(addr=PC); PC = PC + 1
    nn_msb = read_memory(addr=PC); PC = PC + 1
    nn = unsigned_16(lsb=nn_lsb, msb=nn_msb)
    BC = nn
```

Detailed timing and pseudocode

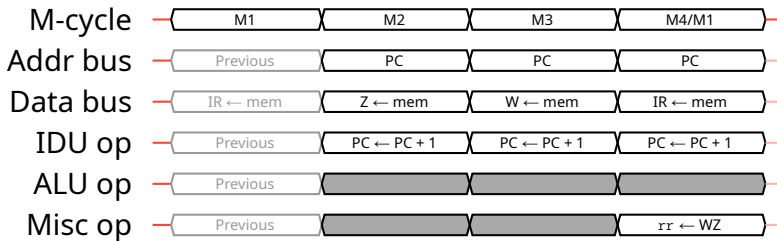

```
# M2
if IR == 0x01: # example: LD BC, nn
    Z = read_memory(addr=PC); PC = PC + 1
# M3
W = read_memory(addr=PC); PC = PC + 1
# M4/M1
IR, intr = fetch_cycle(addr=PC); PC = PC + 1; BC = WZ
```

LD (nn), SP: Load from stack pointer (direct)

Load to the absolute address specified by the 16-bit operand nn, data from the 16-bit SP register.

Opcode 0b00001000/0x08

Duration 5 machine cycles

Length 3 bytes: opcode + LSB(nn) + MSB(nn) **Flags** -

Simple timing and pseudocode



```
opcode = read_memory(addr=PC); PC = PC + 1
```

```
if opcode == 0x08:
```

```
    nn_lsb = read_memory(addr=PC); PC = PC + 1
```

```
    nn_msb = read_memory(addr=PC); PC = PC + 1
```

```
    nn = unsigned_16(lsb=nn_lsb, msb=nn_msb)
```

```
    write_memory(addr=nn, data=lsb(SP)); nn = nn + 1
```

```
    write_memory(addr=nn, data=msb(SP))
```

Detailed timing and pseudocode

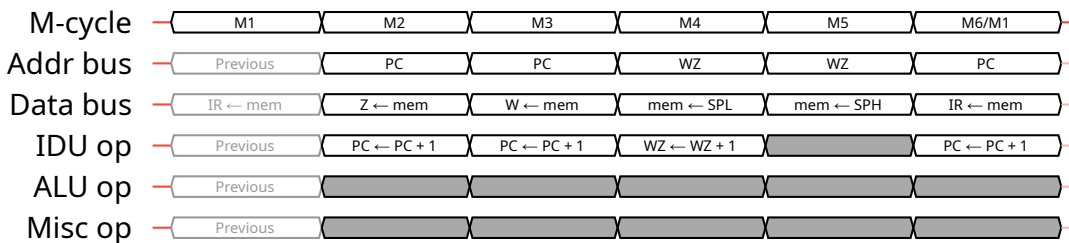

```
# M2
```

```
if IR == 0x08:
```

```
    Z = read_memory(addr=PC); PC = PC + 1
```

```
# M3
```

```
    W = read_memory(addr=PC); PC = PC + 1
```

```
# M4
```

```
    write_memory(addr=WZ, data=lsb(SP)); WZ = WZ + 1
```

```
# M5
```

```
    write_memory(addr=WZ, data=msb(SP))
```

```
# M6/M1
```

```
    IR, intr = fetch_cycle(addr=PC); PC = PC + 1
```

LD SP, HL: Load stack pointer from HL

Load to the 16-bit SP register, data from the 16-bit HL register.

Opcode 0b11111001/0xF9

Duration 2 machine cycles

Length 1 byte: opcode

Flags -

Simple timing and pseudocode

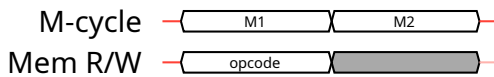

```
opcode = read_memory(addr=PC); PC = PC + 1  
if opcode == 0xF9:  
    SP = HL
```

Detailed timing and pseudocode

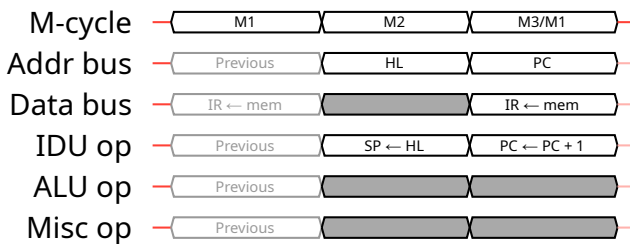

```
# M2  
if IR == 0xF9:  
    SP = HL  
# M3/M1  
IR, intr = fetch_cycle(addr=PC); PC = PC + 1
```

PUSH rr: Push to stack

Push to the stack memory, data from the 16-bit register rr.

Opcode 0b11xx0101/variou

Duration 4 machine cycles

Length 1 byte: opcode

Flags -

Simple timing and pseudocode

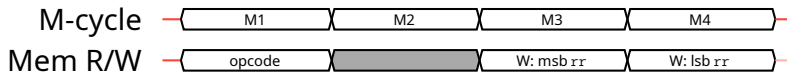

```
opcode = read_memory(addr=PC); PC = PC + 1
```

```
if opcode == 0xC5: # example: PUSH BC
```

```
    SP = SP - 1
```

```
    write_memory(addr=SP, data=msb(BC)); SP = SP - 1
```

```
    write_memory(addr=SP, data=lsb(BC))
```

Detailed timing and pseudocode

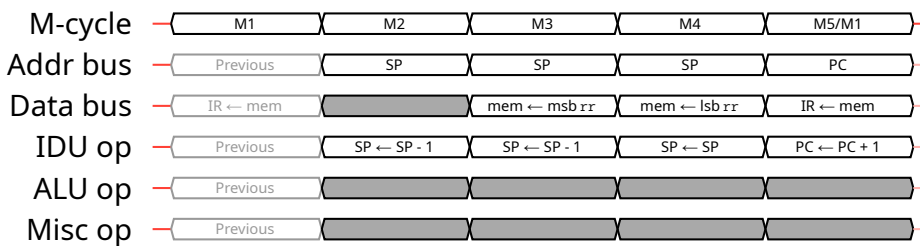

```
# M2
```

```
if IR == 0xC5: # example: PUSH BC
```

```
    SP = SP - 1
```

```
# M3
```

```
    write_memory(addr=SP, data=msb(BC)); SP = SP - 1
```

```
# M4
```

```
    write_memory(addr=SP, data=lsb(BC))
```

```
# M5/M1
```

```
    IR, intr = fetch_cycle(addr=PC); PC = PC + 1
```

POP rr: Pop from stack

Pops to the 16-bit register `rr`, data from the stack memory.

This instruction does not do calculations that affect flags, but POP AF completely replaces the F register value, so all flags are changed based on the 8-bit data that is read from memory.

Opcod `0b11xx0001`/various

Duration 3 machine cycles

Length 1 byte: opcode

Flags See the instruction description

Simple timing and pseudocode



```
opcode = read_memory(addr=PC); PC = PC + 1
```

```
if opcode == 0xC1: # example: POP BC
```

```
    lsb = read_memory(addr=SP); SP = SP + 1
```

```
    msb = read_memory(addr=SP); SP = SP + 1
```

```
    BC = unsigned_16(lsb=lsb, msb=msb)
```

Detailed timing and pseudocode

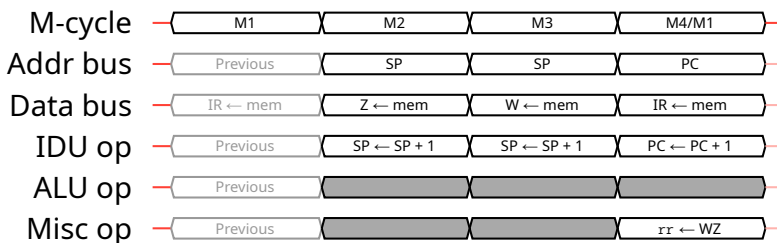

```
# M2
```

```
if IR == 0xC1: # example: POP BC
```

```
    Z = read_memory(addr=SP); SP = SP + 1
```

```
# M3
```

```
    W = read_memory(addr=SP); SP = SP + 1
```

```
# M4/M1
```

```
    IR, intr = fetch_cycle(addr=PC); PC = PC + 1; BC = WZ
```

LD HL, SP+e: Load HL from adjusted stack pointer

Load to the HL register, 16-bit data calculated by adding the signed 8-bit operand *e* to the 16-bit value of the SP register.

Opcode 0b11111000/0xF8

Duration 3 machine cycles

Length 2 bytes: opcode + *e*

Flags Z = 0, N = 0, H = ★, C = ★

Simple timing and pseudocode



```
opcode = read_memory(addr=PC); PC = PC + 1
if opcode == 0xF8:
    e = signed_8(read_memory(addr=PC)); PC = PC + 1
    result, carry_per_bit = SP + e
    HL = result
    flags.Z = 0
    flags.N = 0
    flags.H = 1 if carry_per_bit[3] else 0
    flags.C = 1 if carry_per_bit[7] else 0
```

Detailed timing and pseudocode

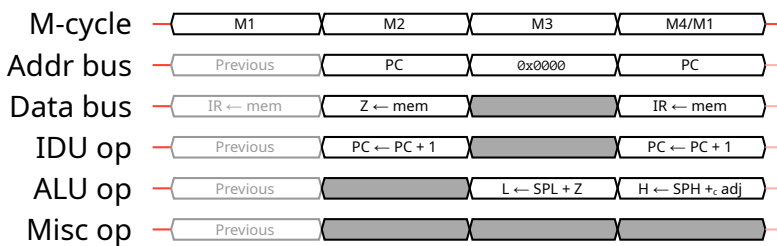

```
# M2
if IR == 0xF8:
    Z = read_memory(addr=PC); PC = PC + 1
# M3
result, carry_per_bit = lsb(SP) + Z
L = result
flags.Z = 0
flags.N = 0
flags.H = 1 if carry_per_bit[3] else 0
flags.C = 1 if carry_per_bit[7] else 0
Z_sign = bit(7, Z)
# M4/M1
adj = 0xFF if Z_sign else 0x00
result = msb(SP) + adj + flags.C
H = result
IR, intr = fetch_cycle(addr=PC); PC = PC + 1
```

6.4 8-bit arithmetic and logical instructions

ADD r: Add (register)

Adds to the 8-bit A register, the 8-bit register r, and stores the result back into the A register.

Opcode 0b10000xxx/variou

Duration 1 machine cycle

Length 1 byte: opcode

Flags Z = ★, N = 0, H = ★, C = ★

Simple timing and pseudocode

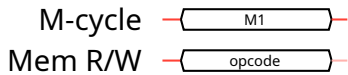

```
opcode = read_memory(addr=PC); PC = PC + 1
```

```
if opcode == 0x80: # example: ADD B
```

```
    result, carry_per_bit = A + B
```

```
    A = result
```

```
    flags.Z = 1 if result == 0 else 0
```

```
    flags.N = 0
```

```
    flags.H = 1 if carry_per_bit[3] else 0
```

```
    flags.C = 1 if carry_per_bit[7] else 0
```

Detailed timing and pseudocode

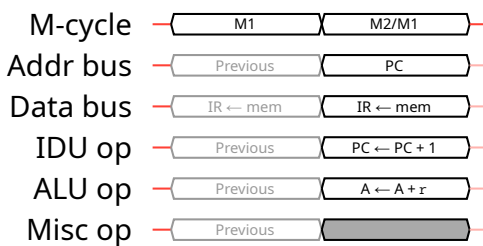

```
# M2/M1
```

```
if IR == 0x80: # example: ADD B
```

```
    result, carry_per_bit = A + B
```

```
    A = result
```

```
    flags.Z = 1 if result == 0 else 0
```

```
    flags.N = 0
```

```
    flags.H = 1 if carry_per_bit[3] else 0
```

```
    flags.C = 1 if carry_per_bit[7] else 0
```

```
    IR, intr = fetch_cycle(addr=PC); PC = PC + 1
```

ADD (HL): Add (indirect HL)

Adds to the 8-bit A register, data from the absolute address specified by the 16-bit register HL, and stores the result back into the A register.

Opcode 0b10000110/0x86

Duration 2 machine cycles

Length 1 byte: opcode

Flags Z = ★, N = 0, H = ★, C = ★

Simple timing and pseudocode

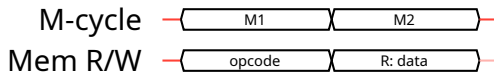

```
opcode = read_memory(addr=PC); PC = PC + 1
```

```
if opcode == 0x86:
```

```
    data = read_memory(addr=HL)
```

```
    result, carry_per_bit = A + data
```

```
    A = result
```

```
    flags.Z = 1 if result == 0 else 0
```

```
    flags.N = 0
```

```
    flags.H = 1 if carry_per_bit[3] else 0
```

```
    flags.C = 1 if carry_per_bit[7] else 0
```

Detailed timing and pseudocode

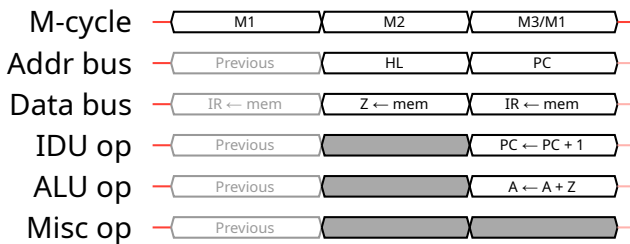

```
# M2
```

```
if IR == 0x86:
```

```
    Z = read_memory(addr=HL)
```

```
    # M3/M1
```

```
    result, carry_per_bit = A + Z
```

```
    A = result
```

```
    flags.Z = 1 if result == 0 else 0
```

```
    flags.N = 0
```

```
    flags.H = 1 if carry_per_bit[3] else 0
```

```
    flags.C = 1 if carry_per_bit[7] else 0
```

```
    IR, intr = fetch_cycle(addr=PC); PC = PC + 1
```

ADD n: Add (immediate)

Adds to the 8-bit A register, the immediate data n , and stores the result back into the A register.

Opcode 0b11000110/0xC6

Duration 2 machine cycles

Length 2 bytes: opcode + n

Flags Z = ★, N = 0, H = ★, C = ★

Simple timing and pseudocode

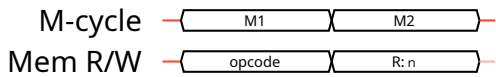

```
opcode = read_memory(addr=PC); PC = PC + 1
```

```
if opcode == 0xC6:
```

```
    n = read_memory(addr=PC); PC = PC + 1
```

```
    result, carry_per_bit = A + n
```

```
    A = result
```

```
    flags.Z = 1 if result == 0 else 0
```

```
    flags.N = 0
```

```
    flags.H = 1 if carry_per_bit[3] else 0
```

```
    flags.C = 1 if carry_per_bit[7] else 0
```

Detailed timing and pseudocode

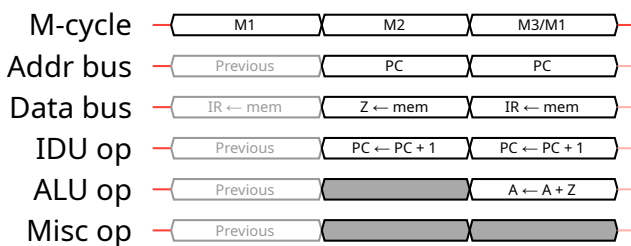

```
# M2
```

```
if IR == 0xC6:
```

```
    Z = read_memory(addr=PC); PC = PC + 1
```

```
    # M3/M1
```

```
    result, carry_per_bit = A + Z
```

```
    A = result
```

```
    flags.Z = 1 if result == 0 else 0
```

```
    flags.N = 0
```

```
    flags.H = 1 if carry_per_bit[3] else 0
```

```
    flags.C = 1 if carry_per_bit[7] else 0
```

```
    IR, intr = fetch_cycle(addr=PC); PC = PC + 1
```

ADC r: Add with carry (register)

Adds to the 8-bit A register, the carry flag and the 8-bit register r, and stores the result back into the A register.

Opcode 0b10001xxx/various

Length 1 byte: opcode

Simple timing and pseudocode

Duration 1 machine cycle

Flags Z = ★, N = 0, H = ★, C = ★

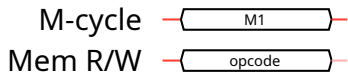

```
opcode = read_memory(addr=PC); PC = PC + 1
if opcode == 0x88: # example: ADC B
    result, carry_per_bit = A + B + flags.C
    A = result
    flags.Z = 1 if result == 0 else 0
    flags.N = 0
    flags.H = 1 if carry_per_bit[3] else 0
    flags.C = 1 if carry_per_bit[7] else 0
```

Detailed timing and pseudocode

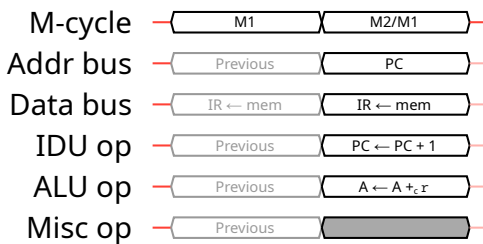

```
# M2/M1
if IR == 0x88: # example: ADC B
    result, carry_per_bit = A + B + flags.C
    A = result
    flags.Z = 1 if result == 0 else 0
    flags.N = 0
    flags.H = 1 if carry_per_bit[3] else 0
    flags.C = 1 if carry_per_bit[7] else 0
    IR, intr = fetch_cycle(addr=PC); PC = PC + 1
```

ADC (HL): Add with carry (indirect HL)

Adds to the 8-bit A register, the carry flag and data from the absolute address specified by the 16-bit register HL, and stores the result back into the A register.

Opcode 0b10001110/0x8E

Duration 2 machine cycles

Length 1 byte: opcode

Flags Z = ★, N = 0, H = ★, C = ★

Simple timing and pseudocode

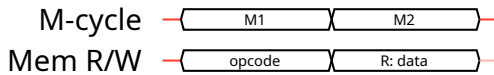

```
opcode = read_memory(addr=PC); PC = PC + 1
if opcode == 0x8E:
    data = read_memory(addr=HL)
    result, carry_per_bit = A + data + flags.C
    A = result
    flags.Z = 1 if result == 0 else 0
    flags.N = 0
    flags.H = 1 if carry_per_bit[3] else 0
    flags.C = 1 if carry_per_bit[7] else 0
```

Detailed timing and pseudocode

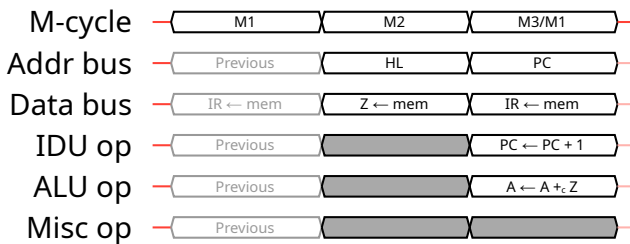

```
# M2
if IR == 0x8E:
    Z = read_memory(addr=HL)
    # M3/M1
    result, carry_per_bit = A + Z + flags.C
    A = result
    flags.Z = 1 if result == 0 else 0
    flags.N = 0
    flags.H = 1 if carry_per_bit[3] else 0
    flags.C = 1 if carry_per_bit[7] else 0
    IR, intr = fetch_cycle(addr=PC); PC = PC + 1
```

ADC n: Add with carry (immediate)

Adds to the 8-bit A register, the carry flag and the immediate data n, and stores the result back into the A register.

Opcode 0b11001110/0xCE

Length 2 bytes: opcode + n

Simple timing and pseudocode

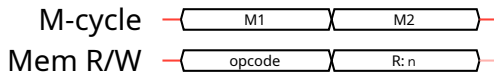

Duration 2 machine cycles

Flags Z = ★, N = 0, H = ★, C = ★

```
opcode = read_memory(addr=PC); PC = PC + 1
if opcode == 0xCE:
    n = read_memory(addr=PC); PC = PC + 1
    result, carry_per_bit = A + n + flags.C
    A = result
    flags.Z = 1 if result == 0 else 0
    flags.N = 0
    flags.H = 1 if carry_per_bit[3] else 0
    flags.C = 1 if carry_per_bit[7] else 0
```

Detailed timing and pseudocode

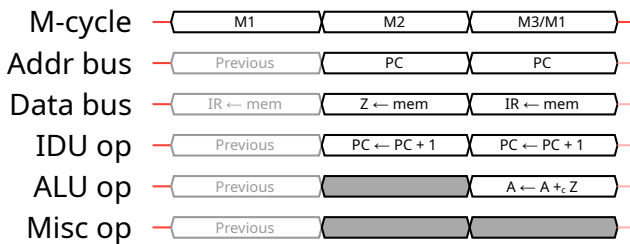

```
# M2
if IR == 0xCE:
    Z = read_memory(addr=PC); PC = PC + 1
    # M3/M1
    result, carry_per_bit = A + Z + flags.C
    A = result
    flags.Z = 1 if result == 0 else 0
    flags.N = 0
    flags.H = 1 if carry_per_bit[3] else 0
    flags.C = 1 if carry_per_bit[7] else 0
    IR, intr = fetch_cycle(addr=PC); PC = PC + 1
```

SUB r: Subtract (register)

Subtracts from the 8-bit A register, the 8-bit register r, and stores the result back into the A register.

Opcode 0b10010xxx/various

Duration 1 machine cycle

Length 1 byte: opcode

Flags Z = ★, N = 1, H = ★, C = ★

Simple timing and pseudocode

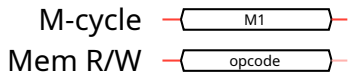

```
opcode = read_memory(addr=PC); PC = PC + 1
```

```
if opcode == 0x90: # example: SUB B  
    result, carry_per_bit = A - B  
    A = result  
    flags.Z = 1 if result == 0 else 0  
    flags.N = 1  
    flags.H = 1 if carry_per_bit[3] else 0  
    flags.C = 1 if carry_per_bit[7] else 0
```

Detailed timing and pseudocode

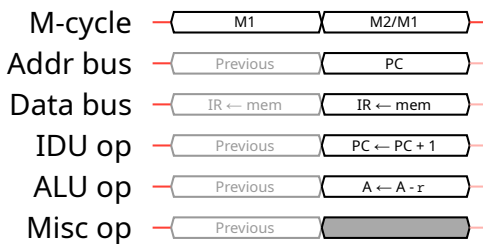

```
# M2/M1  
if IR == 0x90: # example: SUB B  
    result, carry_per_bit = A - B  
    A = result  
    flags.Z = 1 if result == 0 else 0  
    flags.N = 1  
    flags.H = 1 if carry_per_bit[3] else 0  
    flags.C = 1 if carry_per_bit[7] else 0  
    IR, intr = fetch_cycle(addr=PC); PC = PC + 1
```

SUB (HL): Subtract (indirect HL)

Subtracts from the 8-bit A register, data from the absolute address specified by the 16-bit register HL, and stores the result back into the A register.

Opcode 0b10010110/0x96

Duration 2 machine cycles

Length 1 byte: opcode

Flags Z = ★, N = 1, H = ★, C = ★

Simple timing and pseudocode

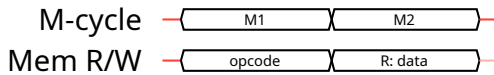

```
opcode = read_memory(addr=PC); PC = PC + 1
if opcode == 0x96:
    data = read_memory(addr=HL)
    result, carry_per_bit = A - data
    A = result
    flags.Z = 1 if result == 0 else 0
    flags.N = 1
    flags.H = 1 if carry_per_bit[3] else 0
    flags.C = 1 if carry_per_bit[7] else 0
```

Detailed timing and pseudocode

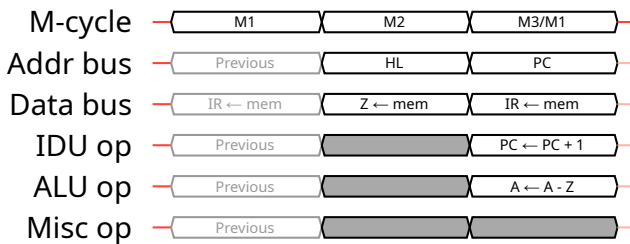

```
# M2
if IR == 0x96:
    Z = read_memory(addr=HL)
    # M3/M1
    result, carry_per_bit = A - Z
    A = result
    flags.Z = 1 if result == 0 else 0
    flags.N = 1
    flags.H = 1 if carry_per_bit[3] else 0
    flags.C = 1 if carry_per_bit[7] else 0
    IR, intr = fetch_cycle(addr=PC); PC = PC + 1
```

SUB n: Subtract (immediate)

Subtracts from the 8-bit A register, the immediate data n, and stores the result back into the A register.

Opcode 0b11010110/0xD6

Duration 2 machine cycles

Length 2 bytes: opcode + n

Flags Z = ★, N = 1, H = ★, C = ★

Simple timing and pseudocode

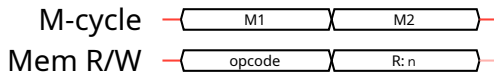

```
opcode = read_memory(addr=PC); PC = PC + 1
```

```
if opcode == 0xD6:
```

```
    n = read_memory(addr=PC); PC = PC + 1
```

```
    result, carry_per_bit = A - n
```

```
    A = result
```

```
    flags.Z = 1 if result == 0 else 0
```

```
    flags.N = 1
```

```
    flags.H = 1 if carry_per_bit[3] else 0
```

```
    flags.C = 1 if carry_per_bit[7] else 0
```

Detailed timing and pseudocode

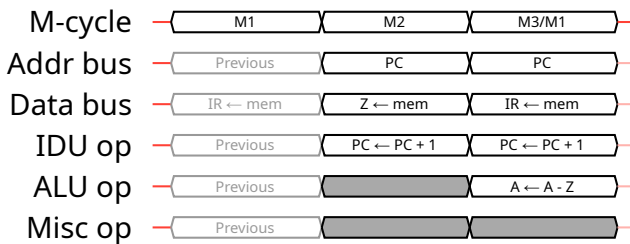

```
# M2
```

```
if IR == 0xD6:
```

```
    Z = read_memory(addr=PC); PC = PC + 1
```

```
    # M3/M1
```

```
    result, carry_per_bit = A - Z
```

```
    A = result
```

```
    flags.Z = 1 if result == 0 else 0
```

```
    flags.N = 1
```

```
    flags.H = 1 if carry_per_bit[3] else 0
```

```
    flags.C = 1 if carry_per_bit[7] else 0
```

```
    IR, intr = fetch_cycle(addr=PC); PC = PC + 1
```

SBC r: Subtract with carry (register)

Subtracts from the 8-bit A register, the carry flag and the 8-bit register r, and stores the result back into the A register.

Opcode 0b10011xxx/various

Duration 1 machine cycle

Length 1 byte: opcode

Flags Z = ★, N = 1, H = ★, C = ★

Simple timing and pseudocode

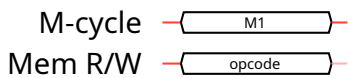

```
opcode = read_memory(addr=PC); PC = PC + 1
if opcode == 0x98: # example: SBC B
    result, carry_per_bit = A - B - flags.C
    A = result
    flags.Z = 1 if result == 0 else 0
    flags.N = 1
    flags.H = 1 if carry_per_bit[3] else 0
    flags.C = 1 if carry_per_bit[7] else 0
```

Detailed timing and pseudocode

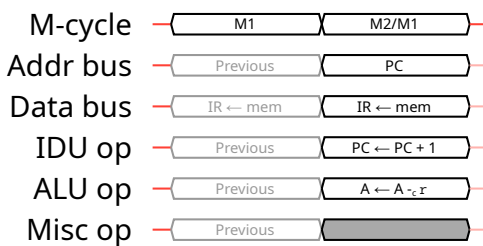

```
# M2/M1
if IR == 0x98: # example: SBC B
    result, carry_per_bit = A - B - flags.C
    A = result
    flags.Z = 1 if result == 0 else 0
    flags.N = 1
    flags.H = 1 if carry_per_bit[3] else 0
    flags.C = 1 if carry_per_bit[7] else 0
    IR, intr = fetch_cycle(addr=PC); PC = PC + 1
```

SBC (HL): Subtract with carry (indirect HL)

Subtracts from the 8-bit A register, the carry flag and data from the absolute address specified by the 16-bit register HL, and stores the result back into the A register.

Opcode 0b10011110/0x9E

Duration 2 machine cycles

Length 1 byte: opcode

Flags Z = ★, N = 1, H = ★, C = ★

Simple timing and pseudocode

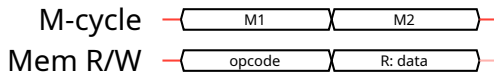

```
opcode = read_memory(addr=PC); PC = PC + 1
if opcode == 0x9E:
    data = read_memory(addr=HL)
    result, carry_per_bit = A - data - flags.C
    A = result
    flags.Z = 1 if result == 0 else 0
    flags.N = 1
    flags.H = 1 if carry_per_bit[3] else 0
    flags.C = 1 if carry_per_bit[7] else 0
```

Detailed timing and pseudocode

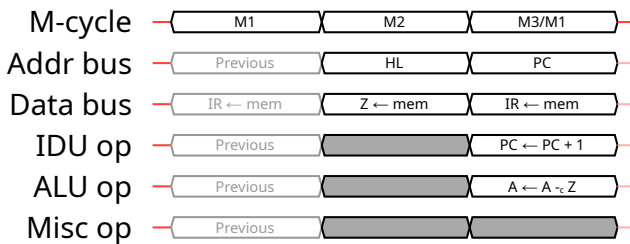

```
# M2
if IR == 0x9E:
    Z = read_memory(addr=HL)
    # M3/M1
    result, carry_per_bit = A - Z - flags.C
    A = result
    flags.Z = 1 if result == 0 else 0
    flags.N = 1
    flags.H = 1 if carry_per_bit[3] else 0
    flags.C = 1 if carry_per_bit[7] else 0
    IR, intr = fetch_cycle(addr=PC); PC = PC + 1
```



SBC n: Subtract with carry (immediate)

Subtracts from the 8-bit A register, the carry flag and the immediate data n, and stores the result back into the A register.

Opcode 0b11011110/0xDE

Length 2 bytes: opcode + n

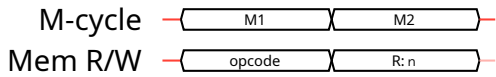
Simple timing and pseudocode



Duration 2 machine cycles

Flags Z = ★, N = 1, H = ★, C = ★

```
opcode = read_memory(addr=PC); PC = PC + 1
if opcode == 0xDE:
    n = read_memory(addr=PC); PC = PC + 1
    result, carry_per_bit = A - n - flags.C
    A = result
    flags.Z = 1 if result == 0 else 0
    flags.N = 1
    flags.H = 1 if carry_per_bit[3] else 0
    flags.C = 1 if carry_per_bit[7] else 0
```

Detailed timing and pseudocode

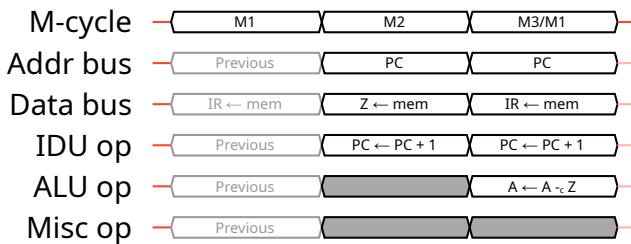

```
# M2
if IR == 0xDE:
    Z = read_memory(addr=PC); PC = PC + 1
    # M3/M1
    result, carry_per_bit = A - Z - flags.C
    A = result
    flags.Z = 1 if result == 0 else 0
    flags.N = 1
    flags.H = 1 if carry_per_bit[3] else 0
    flags.C = 1 if carry_per_bit[7] else 0
    IR, intr = fetch_cycle(addr=PC); PC = PC + 1
```

CP r: Compare (register)

Subtracts from the 8-bit A register, the 8-bit register r , and updates flags based on the result. This instruction is basically identical to SUB r , but does not update the A register.

Opcode 0b10111xxx/various

Duration 1 machine cycle

Length 1 byte: opcode

Flags Z = ★, N = 1, H = ★, C = ★

Simple timing and pseudocode

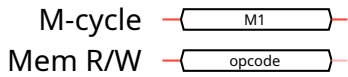

```
opcode = read_memory(addr=PC); PC = PC + 1
```

```
if opcode == 0xB8: # example: CP B
    result, carry_per_bit = A - B
    flags.Z = 1 if result == 0 else 0
    flags.N = 1
    flags.H = 1 if carry_per_bit[3] else 0
    flags.C = 1 if carry_per_bit[7] else 0
```

Detailed timing and pseudocode

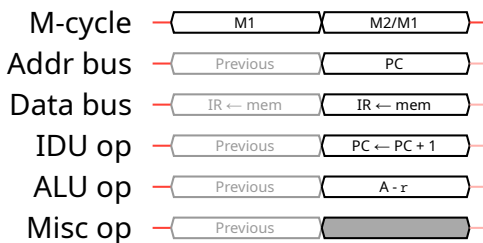

```
# M2/M1
if IR == 0xB8: # example: CP B
    result, carry_per_bit = A - B
    flags.Z = 1 if result == 0 else 0
    flags.N = 1
    flags.H = 1 if carry_per_bit[3] else 0
    flags.C = 1 if carry_per_bit[7] else 0
    IR, intr = fetch_cycle(addr=PC); PC = PC + 1
```

CP (HL): Compare (indirect HL)

Subtracts from the 8-bit A register, data from the absolute address specified by the 16-bit register HL, and updates flags based on the result. This instruction is basically identical to SUB (HL), but does not update the A register.

Opcode 0b10011110/0x9E

Length 1 byte: opcode

Duration 2 machine cycles

Flags Z = ★, N = 1, H = ★, C = ★

Simple timing and pseudocode

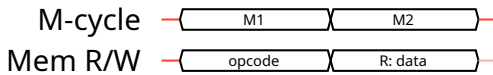

```
opcode = read_memory(addr=PC); PC = PC + 1
if opcode == 0xBE:
    data = read_memory(addr=HL)
    result, carry_per_bit = A - data
    flags.Z = 1 if result == 0 else 0
    flags.N = 1
    flags.H = 1 if carry_per_bit[3] else 0
    flags.C = 1 if carry_per_bit[7] else 0
```

Detailed timing and pseudocode

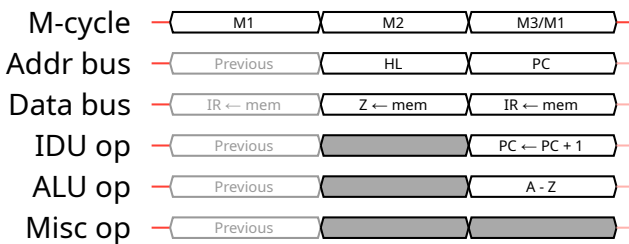

```
# M2
if IR == 0xBE:
    Z = read_memory(addr=HL)
# M3/M1
result, carry_per_bit = A - Z
flags.Z = 1 if result == 0 else 0
flags.N = 1
flags.H = 1 if carry_per_bit[3] else 0
flags.C = 1 if carry_per_bit[7] else 0
IR, intr = fetch_cycle(addr=PC); PC = PC + 1
```

CP n: Compare (immediate)

Subtracts from the 8-bit A register, the immediate data n , and updates flags based on the result. This instruction is basically identical to SUB n , but does not update the A register.

Opcode 0b11111110/0xFE

Duration 2 machine cycles

Length 2 bytes: opcode + n

Flags Z = ★, N = 1, H = ★, C = ★

Simple timing and pseudocode

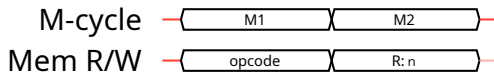

```
opcode = read_memory(addr=PC); PC = PC + 1
```

```
if opcode == 0xFE:
```

```
    n = read_memory(addr=PC); PC = PC + 1
```

```
    result, carry_per_bit = A - n
```

```
    flags.Z = 1 if result == 0 else 0
```

```
    flags.N = 1
```

```
    flags.H = 1 if carry_per_bit[3] else 0
```

```
    flags.C = 1 if carry_per_bit[7] else 0
```

Detailed timing and pseudocode

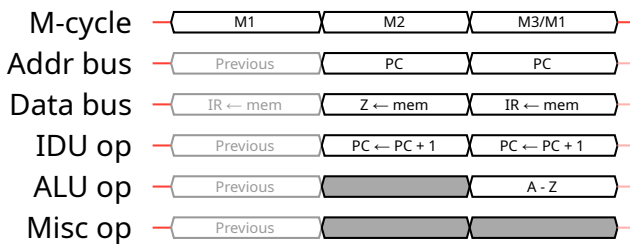

```
# M2
```

```
if IR == 0xFE:
```

```
    Z = read_memory(addr=PC); PC = PC + 1
```

```
# M3/M1
```

```
result, carry_per_bit = A - Z
```

```
flags.Z = 1 if result == 0 else 0
```

```
flags.N = 1
```

```
flags.H = 1 if carry_per_bit[3] else 0
```

```
flags.C = 1 if carry_per_bit[7] else 0
```

INC r: Increment (register)

Increments data in the 8-bit register r .

Opcode $0b00xxx100$ /various

Length 1 byte: opcode

Simple timing and pseudocode

Duration 1 machine cycle

Flags $Z = \star, N = 0, H = \star$

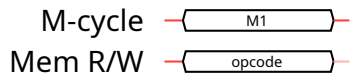

```
opcode = read_memory(addr=PC); PC = PC + 1
```

```
if opcode == 0x04: # example: INC B
```

```
    result, carry_per_bit = B + 1
```

```
    B = result
```

```
    flags.Z = 1 if result == 0 else 0
```

```
    flags.N = 0
```

```
    flags.H = 1 if carry_per_bit[3] else 0
```

Detailed timing and pseudocode

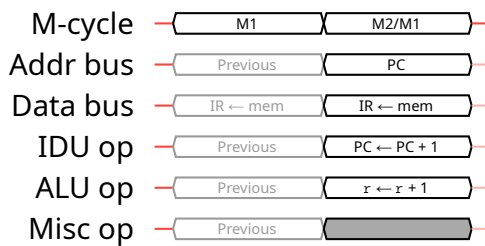

```
if opcode == 0x04: # example: INC B
```

```
    # M2/M1
```

```
    result, carry_per_bit = B + 1
```

```
    B = result
```

```
    flags.Z = 1 if result == 0 else 0
```

```
    flags.N = 0
```

```
    flags.H = 1 if carry_per_bit[3] else 0
```

```
    IR, intr = fetch_cycle(addr=PC); PC = PC + 1
```

INC (HL): Increment (indirect HL)

Increments data at the absolute address specified by the 16-bit register HL.

Opcode 0b00110100/0x34

Duration 3 machine cycles

Length 1 byte: opcode

Flags Z = ★, N = 0, H = ★

Simple timing and pseudocode



```
opcode = read_memory(addr=PC); PC = PC + 1
```

```
if opcode == 0x34:
```

```
    data = read_memory(addr=HL)
```

```
    result, carry_per_bit = data + 1
```

```
    write_memory(addr=HL, data=result)
```

```
    flags.Z = 1 if result == 0 else 0
```

```
    flags.N = 0
```

```
    flags.H = 1 if carry_per_bit[3] else 0
```

Detailed timing and pseudocode

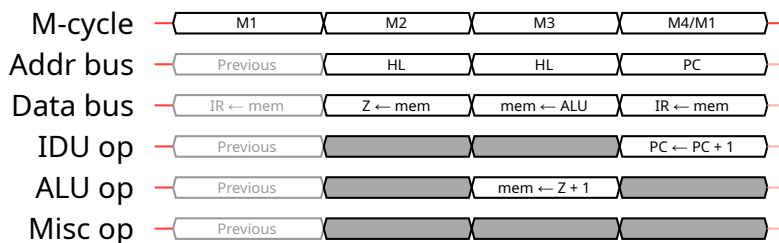

```
# M2
```

```
if IR == 0x34:
```

```
    Z = read_memory(addr=HL)
```

```
    # M3
```

```
    result, carry_per_bit = Z + 1
```

```
    write_memory(addr=HL, data=result)
```

```
    flags.Z = 1 if result == 0 else 0
```

```
    flags.N = 0
```

```
    flags.H = 1 if carry_per_bit[3] else 0
```

```
    # M4/M1
```

```
    IR, intr = fetch_cycle(addr=PC); PC = PC + 1
```

DEC r: Decrement (register)

Increments data in the 8-bit register r .

Opcode $0b00xxx101$ /various

Length 1 byte: opcode

Simple timing and pseudocode

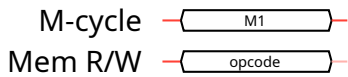

Duration 1 machine cycle

Flags Z = ★, N = 1, H = ★

```
opcode = read_memory(addr=PC); PC = PC + 1
```

```
# example: DEC B
```

```
if opcode == 0x05:
```

```
    result, carry_per_bit = B - 1
```

```
    B = result
```

```
    flags.Z = 1 if result == 0 else 0
```

```
    flags.N = 1
```

```
    flags.H = 1 if carry_per_bit[3] else 0
```

Detailed timing and pseudocode

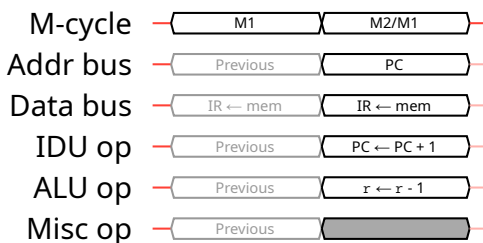

```
# M2/M1
```

```
if IR == 0x05: # example: DEC B
```

```
    result, carry_per_bit = B - 1
```

```
    B = result
```

```
    flags.Z = 1 if result == 0 else 0
```

```
    flags.N = 1
```

```
    flags.H = 1 if carry_per_bit[3] else 0
```

```
    IR, intr = fetch_cycle(addr=PC); PC = PC + 1
```

DEC (HL): Decrement (indirect HL)

Decrements data at the absolute address specified by the 16-bit register HL.

Opcode 0b00110101/0x35

Duration 3 machine cycles

Length 1 byte: opcode

Flags Z = ★, N = 1, H = ★

Simple timing and pseudocode



```
opcode = read_memory(addr=PC); PC = PC + 1
```

```
if opcode == 0x35:
```

```
    data = read_memory(addr=HL)
```

```
    result, carry_per_bit = data - 1
```

```
    write_memory(addr=HL, data=result)
```

```
    flags.Z = 1 if result == 0 else 0
```

```
    flags.N = 1
```

```
    flags.H = 1 if carry_per_bit[3] else 0
```

Detailed timing and pseudocode

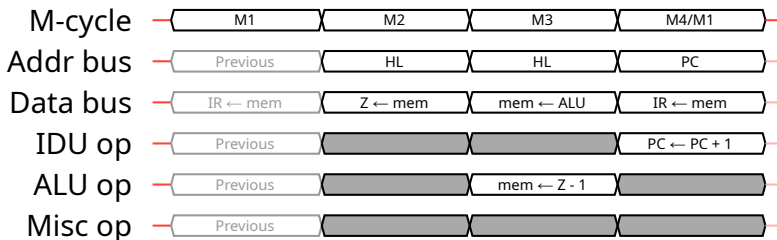

```
# M2
```

```
if IR == 0x35:
```

```
    Z = read_memory(addr=HL)
```

```
    # M3
```

```
    result, carry_per_bit = Z - 1
```

```
    write_memory(addr=HL, data=result)
```

```
    flags.Z = 1 if result == 0 else 0
```

```
    flags.N = 1
```

```
    flags.H = 1 if carry_per_bit[3] else 0
```

```
    # M4/M1
```

```
    IR, intr = fetch_cycle(addr=PC); PC = PC + 1
```

AND r: Bitwise AND (register)

Performs a bitwise AND operation between the 8-bit A register and the 8-bit register r, and stores the result back into the A register.

Opcode 0b10100xxx/variou

Length 1 byte: opcode

Simple timing and pseudocode

Duration 1 machine cycle

Flags Z = ★, N = 0, H = 1, C = 0

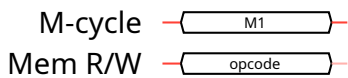

```
opcode = read_memory(addr=PC); PC = PC + 1
```

```
if opcode == 0xA0: # example: AND B
```

```
    result = A & B
```

```
    A = result
```

```
    flags.Z = 1 if result == 0 else 0
```

```
    flags.N = 0
```

```
    flags.H = 1
```

```
    flags.C = 0
```

Detailed timing and pseudocode

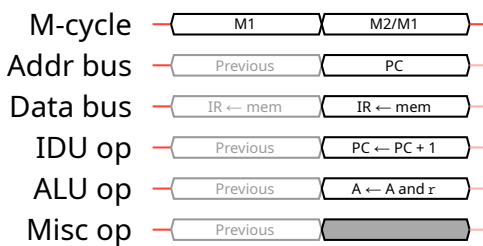

```
# M2/M1
```

```
if IR == 0xA0: # example: AND B
```

```
    result = A & B
```

```
    A = result
```

```
    flags.Z = 1 if result == 0 else 0
```

```
    flags.N = 0
```

```
    flags.H = 1
```

```
    flags.C = 0
```

```
    IR, intr = fetch_cycle(addr=PC); PC = PC + 1
```

AND (HL): Bitwise AND (indirect HL)

Performs a bitwise AND operation between the 8-bit A register and data from the absolute address specified by the 16-bit register HL, and stores the result back into the A register.

Opcode 0b10100110/0xA6

Duration 2 machine cycles

Length 1 byte: opcode

Flags Z = ★, N = 0, H = 1, C = 0

Simple timing and pseudocode

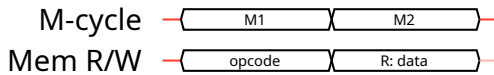

```
opcode = read_memory(addr=PC); PC = PC + 1
```

```
if opcode == 0xA6:  
    data = read_memory(addr=HL)  
    result = A & data  
    A = result  
    flags.Z = 1 if result == 0 else 0  
    flags.N = 0  
    flags.H = 1  
    flags.C = 0
```

Detailed timing and pseudocode

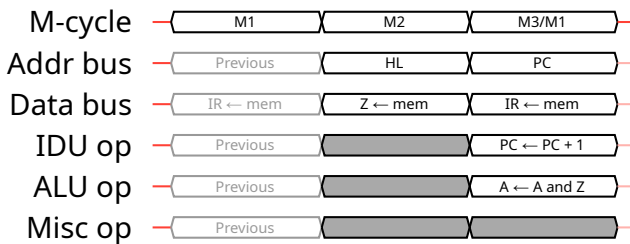

```
# M2  
if IR == 0xA6:  
    Z = read_memory(addr=HL)  
    # M3/M1  
    result = A & Z  
    A = result  
    flags.Z = 1 if result == 0 else 0  
    flags.N = 0  
    flags.H = 1  
    flags.C = 0  
    IR, intr = fetch_cycle(addr=PC); PC = PC + 1
```

AND n: Bitwise AND (immediate)

Performs a bitwise AND operation between the 8-bit A register and immediate data n, and stores the result back into the A register.

Opcode 0b11100110/0xE6

Length 2 bytes: opcode + n

Duration 2 machine cycles

Flags Z = ★, N = 0, H = 1, C = 0

Simple timing and pseudocode

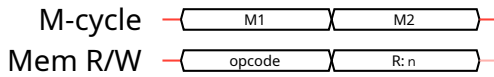

```
opcode = read_memory(addr=PC); PC = PC + 1
```

```
if opcode == 0xE6:
```

```
    n = read_memory(addr=PC); PC = PC + 1
```

```
    result = A & n
```

```
    A = result
```

```
    flags.Z = 1 if result == 0 else 0
```

```
    flags.N = 0
```

```
    flags.H = 1
```

```
    flags.C = 0
```

Detailed timing and pseudocode

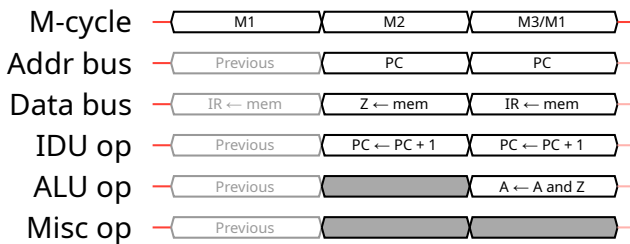

```
# M2
```

```
if IR == 0xE6:
```

```
    Z = read_memory(addr=PC); PC = PC + 1
```

```
    # M3/M1
```

```
    result = A & Z
```

```
    A = result
```

```
    flags.Z = 1 if result == 0 else 0
```

```
    flags.N = 0
```

```
    flags.H = 1
```

```
    flags.C = 0
```

```
    IR, intr = fetch_cycle(addr=PC); PC = PC + 1
```

OR r: Bitwise OR (register)

Performs a bitwise OR operation between the 8-bit A register and the 8-bit register r , and stores the result back into the A register.

Opcode 0b10110xxx/variou

Duration 1 machine cycle

Length 1 byte: opcode

Flags Z = ★, N = 0, H = 0, C = 0

Simple timing and pseudocode

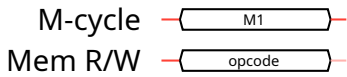

```
opcode = read_memory(addr=PC); PC = PC + 1
```

```
if opcode == 0xB0: # example: OR B  
    result = A | B  
    A = result  
    flags.Z = 1 if result == 0 else 0  
    flags.N = 0  
    flags.H = 0  
    flags.C = 0
```

Detailed timing and pseudocode

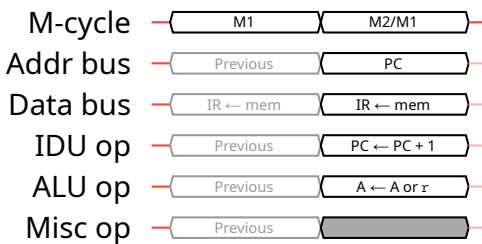

```
# M2/M1  
if IR == 0xB0: # example: OR B  
    result = A | B  
    A = result  
    flags.Z = 1 if result == 0 else 0  
    flags.N = 0  
    flags.H = 0  
    flags.C = 0  
    IR, intr = fetch_cycle(addr=PC); PC = PC + 1
```

OR (HL): Bitwise OR (indirect HL)

Performs a bitwise OR operation between the 8-bit A register and data from the absolute address specified by the 16-bit register HL, and stores the result back into the A register.

Opcode 0b10110110/0xB6

Duration 2 machine cycles

Length 1 byte: opcode

Flags Z = ★, N = 0, H = 0, C = 0

Simple timing and pseudocode

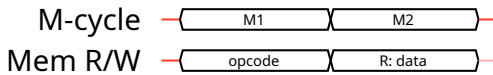

```
opcode = read_memory(addr=PC); PC = PC + 1
```

```
if opcode == 0xB6:  
    data = read_memory(addr=HL)  
    result = A | data  
    A = result  
    flags.Z = 1 if result == 0 else 0  
    flags.N = 0  
    flags.H = 0  
    flags.C = 0
```

Detailed timing and pseudocode

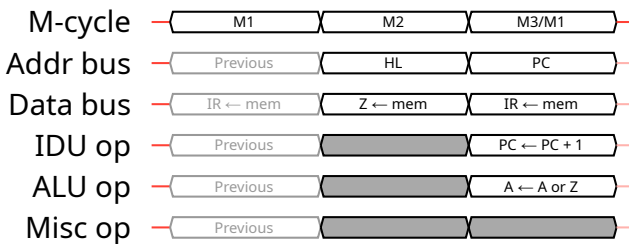

```
# M2  
if IR == 0xB6:  
    Z = read_memory(addr=HL)  
    # M3/M1  
    result = A | Z  
    A = result  
    flags.Z = 1 if result == 0 else 0  
    flags.N = 0  
    flags.H = 0  
    flags.C = 0  
    IR, intr = fetch_cycle(addr=PC); PC = PC + 1
```

OR n: Bitwise OR (immediate)

Performs a bitwise OR operation between the 8-bit A register and immediate data n, and stores the result back into the A register.

Opcode 0b11110110/0xF6

Length 2 bytes: opcode + n

Simple timing and pseudocode

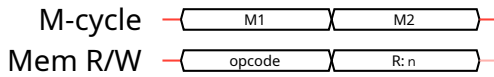

```
opcode = read_memory(addr=PC); PC = PC + 1
```

```
if opcode == 0xF6:
```

```
    n = read_memory(addr=PC); PC = PC + 1
```

```
    result = A | n
```

```
    A = result
```

```
    flags.Z = 1 if result == 0 else 0
```

```
    flags.N = 0
```

```
    flags.H = 0
```

```
    flags.C = 0
```

Detailed timing and pseudocode

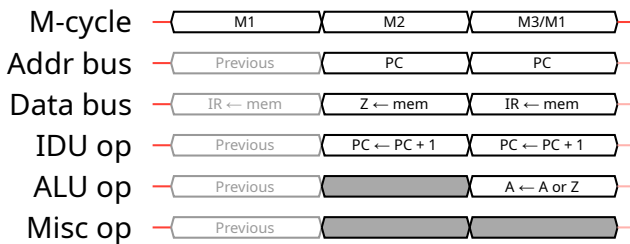

```
# M2
```

```
if IR == 0xF6:
```

```
    Z = read_memory(addr=PC); PC = PC + 1
```

```
    # M3/M1
```

```
    result = A | Z
```

```
    A = result
```

```
    flags.Z = 1 if result == 0 else 0
```

```
    flags.N = 0
```

```
    flags.H = 0
```

```
    flags.C = 0
```

```
    IR, intr = fetch_cycle(addr=PC); PC = PC + 1
```

XOR r: Bitwise XOR (register)

Performs a bitwise XOR operation between the 8-bit A register and the 8-bit register r, and stores the result back into the A register.

Opcode 0b10101xxx/variou

Duration 1 machine cycle

Length 1 byte: opcode

Flags Z = ★, N = 0, H = 0, C = 0

Simple timing and pseudocode

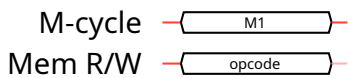

```
opcode = read_memory(addr=PC); PC = PC + 1
```

```
if opcode == 0xA8: # example: XOR B
```

```
    result = A ^ B
```

```
    A = result
```

```
    flags.Z = 1 if result == 0 else 0
```

```
    flags.N = 0
```

```
    flags.H = 0
```

```
    flags.C = 0
```

Detailed timing and pseudocode

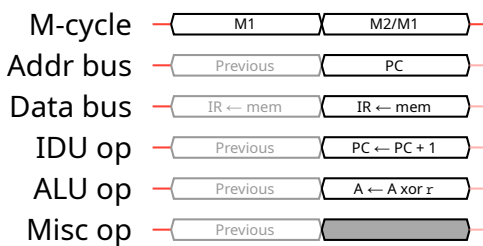

```
opcode = read_memory(addr=PC); PC = PC + 1
```

```
if opcode == 0xA8: # example: XOR B
```

```
    # M2/M1
```

```
    result = A ^ B
```

```
    A = result
```

```
    flags.Z = 1 if result == 0 else 0
```

```
    flags.N = 0
```

```
    flags.H = 0
```

```
    flags.C = 0
```

```
    IR, intr = fetch_cycle(addr=PC); PC = PC + 1
```

XOR (HL): Bitwise XOR (indirect HL)

Performs a bitwise XOR operation between the 8-bit A register and data from the absolute address specified by the 16-bit register HL, and stores the result back into the A register.

Opcode 0b10101110/0xAE

Duration 2 machine cycles

Length 1 byte: opcode

Flags Z = ★, N = 0, H = 0, C = 0

Simple timing and pseudocode

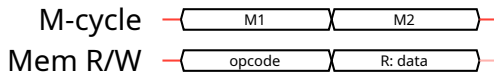

```
opcode = read_memory(addr=PC); PC = PC + 1
```

```
if opcode == 0xAE:  
    data = read_memory(addr=HL)  
    result = A ^ data  
    A = result  
    flags.Z = 1 if result == 0 else 0  
    flags.N = 0  
    flags.H = 0  
    flags.C = 0
```

Detailed timing and pseudocode

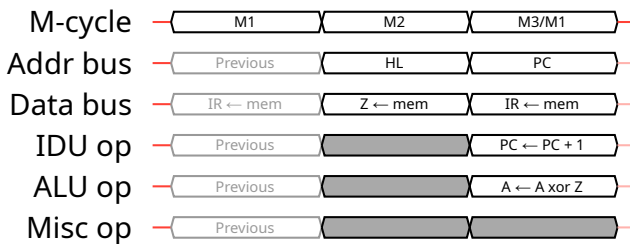

```
# M2  
if IR == 0xAE:  
    Z = read_memory(addr=HL)  
    # M3/M1  
    result = A ^ Z  
    A = result  
    flags.Z = 1 if result == 0 else 0  
    flags.N = 0  
    flags.H = 0  
    flags.C = 0  
    IR, intr = fetch_cycle(addr=PC); PC = PC + 1
```



XOR n: Bitwise XOR (immediate)

Performs a bitwise XOR operation between the 8-bit A register and immediate data n, and stores the result back into the A register.

Opcode 0b11101110/0xEE

Length 2 bytes: opcode + n

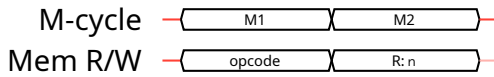
Simple timing and pseudocode



Duration 2 machine cycles

Flags Z = ★, N = 0, H = 0, C = 0

```
opcode = read_memory(addr=PC); PC = PC + 1
if opcode == 0xEE:
    n = read_memory(addr=PC); PC = PC + 1
    result = A ^ n
    A = result
    flags.Z = 1 if result == 0 else 0
    flags.N = 0
    flags.H = 0
    flags.C = 0
```

Detailed timing and pseudocode

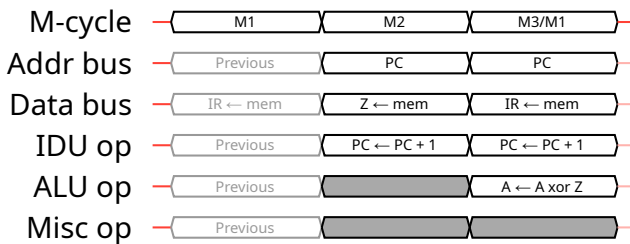

```
# M2
if IR == 0xEE:
    Z = read_memory(addr=PC); PC = PC + 1
    # M3/M1
    result = A ^ Z
    A = result
    flags.Z = 1 if result == 0 else 0
    flags.N = 0
    flags.H = 0
    flags.C = 0
    IR, intr = fetch_cycle(addr=PC); PC = PC + 1
```

CCF: Complement carry flag

Flips the carry flag, and clears the N and H flags.

Opcode 0b00111111/0x3F

Duration 1 machine cycle

Length 1 byte: opcode

Flags N = 0, H = 0, C = ★

Simple timing and pseudocode

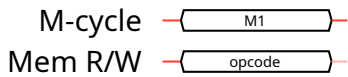

```
opcode = read_memory(addr=PC); PC = PC + 1  
if opcode == 0x3F:  
    flags.N = 0  
    flags.H = 0  
    flags.C = ~flags.C
```

Detailed timing and pseudocode

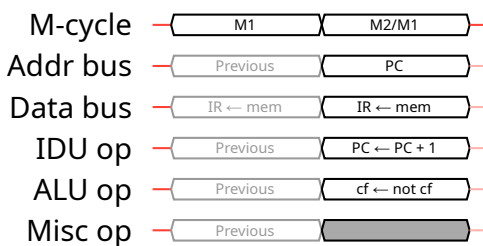

```
# M2/M1  
if IR == 0x3F:  
    flags.N = 0  
    flags.H = 0  
    flags.C = ~flags.C  
    IR, intr = fetch_cycle(addr=PC); PC = PC + 1
```

SCF: Set carry flag

Sets the carry flag, and clears the N and H flags.

Opcode 0b00110111/0x37

Duration 1 machine cycle

Length 1 byte: opcode

Flags N = 0, H = 0, C = 1

Simple timing and pseudocode

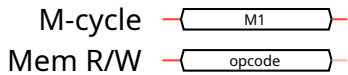

```
opcode = read_memory(addr=PC); PC = PC + 1  
if opcode == 0x37:  
    flags.N = 0  
    flags.H = 0  
    flags.C = 1
```

Detailed timing and pseudocode

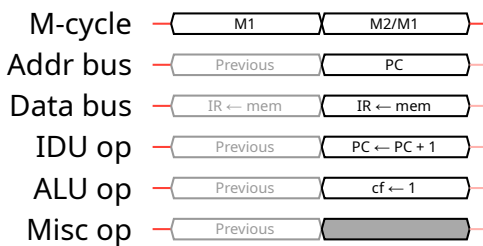

```
# M2/M1  
if IR == 0x37:  
    flags.N = 0  
    flags.H = 0  
    flags.C = 1  
    IR, intr = fetch_cycle(addr=PC); PC = PC + 1
```

DAA: Decimal adjust accumulator

TODO

Opcode 0b00100111/0x27

Length 1 byte: opcode

Simple timing and pseudocode

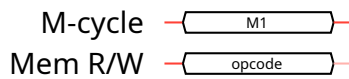

Duration 1 machine cycle

Flags Z = ★, H = 0, C = ★

Detailed timing and pseudocode

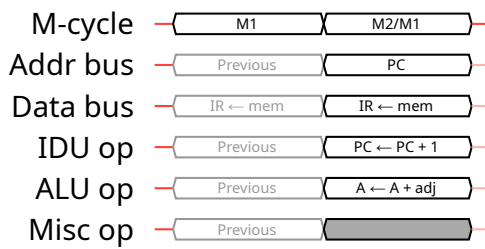

TODO

CPL: Complement accumulator

Flips all the bits in the 8-bit A register, and sets the N and H flags.

Opcode 0b00101111/0x2F

Duration 1 machine cycle

Length 1 byte: opcode

Flags N = 1, H = 1

Simple timing and pseudocode

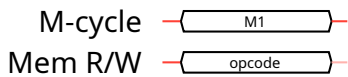

```
opcode = read_memory(addr=PC); PC = PC + 1
if opcode == 0x2F:
    A = ~A
    flags.N = 1
    flags.H = 1
```

Detailed timing and pseudocode

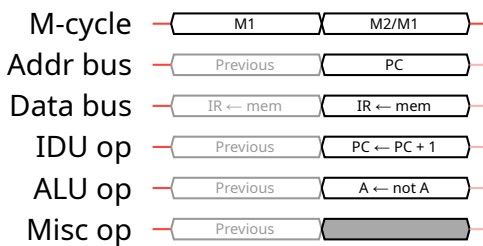

```
# M2/M1
if IR == 0x2F:
    A = ~A
    flags.N = 1
    flags.H = 1
    IR, intr = fetch_cycle(addr=PC); PC = PC + 1
```

6.5 16-bit arithmetic instructions

INC rr: Increment 16-bit register

Increments data in the 16-bit register rr.

Opcode 0b00xx0011/variou

Duration 2 machine cycles

Length 1 byte: opcode

Flags -

Simple timing and pseudocode

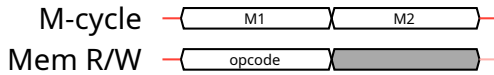

```
opcode = read_memory(addr=PC); PC = PC + 1
if opcode == 0x03: # example: INC BC
    BC = BC + 1
```

Detailed timing and pseudocode

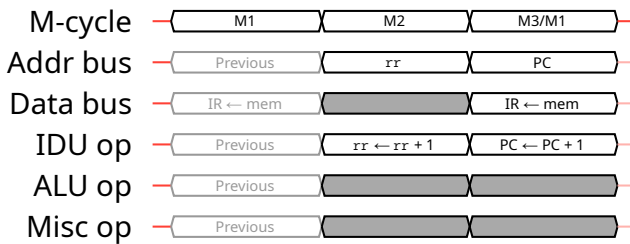

```
# M2
if IR == 0x03: # example: INC BC
    BC = BC + 1
# M3/M1
IR, intr = fetch_cycle(addr=PC); PC = PC + 1
```

DEC rr: Decrement 16-bit register

Decrements data in the 16-bit register rr.

Opcode 0b00xx1011/variou

Length 1 byte: opcode

Simple timing and pseudocode

Duration 2 machine cycles

Flags -

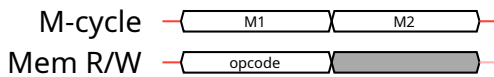

```
opcode = read_memory(addr=PC); PC = PC + 1  
if opcode == 0x0B: # example: DEC BC  
    BC = BC - 1
```

Detailed timing and pseudocode

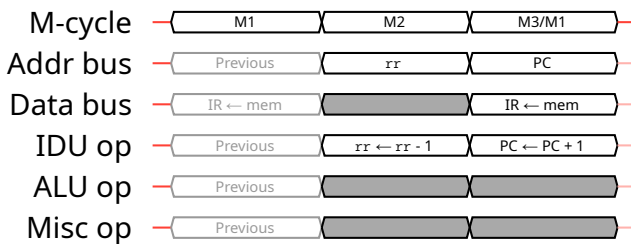

```
# M2  
if IR == 0x0B: # example: DEC BC  
    BC = BC - 1  
# M3/M1  
IR, intr = fetch_cycle(addr=PC); PC = PC + 1
```

ADD HL, rr: Add (16-bit register)

Adds to the 16-bit HL register pair, the 16-bit register `rr`, and stores the result back into the HL register pair.

Opcode `0b00xx1001`/various

Duration 2 machine cycles

Length 1 byte: opcode

Flags N = 0, H = ★, C = ★

Simple timing and pseudocode

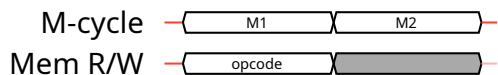

```
opcode = read_memory(addr=PC); PC = PC + 1
if opcode == 0x09: # example: ADD HL, BC
    result, carry_per_bit = HL + BC
    HL = result
    flags.N = 0
    flags.H = 1 if carry_per_bit[11] else 0
    flags.C = 1 if carry_per_bit[15] else 0
```

Detailed timing and pseudocode

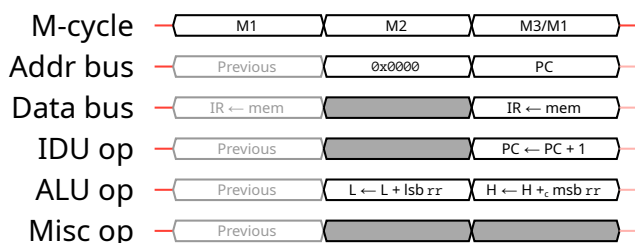

```
# M2
if IR == 0x09: # example: ADD HL, BC
    result, carry_per_bit = L + C
    L = result
    flags.N = 0
    flags.H = 1 if carry_per_bit[3] else 0
    flags.C = 1 if carry_per_bit[7] else 0
# M3/M1
result, carry_per_bit = H + B + flags.C
H = result
flags.N = 0
flags.H = 1 if carry_per_bit[3] else 0
flags.C = 1 if carry_per_bit[7] else 0
IR, intr = fetch_cycle(addr=PC); PC = PC + 1
```

ADD SP, e: Add to stack pointer (relative)

Loads to the 16-bit SP register, 16-bit data calculated by adding the signed 8-bit operand *e* to the 16-bit value of the SP register.

Opcode 0b11101000/0xE8

Duration 4 machine cycles

Length 2 bytes: opcode + *e*

Flags Z = 0, N = 0, H = ★, C = ★

Simple timing and pseudocode

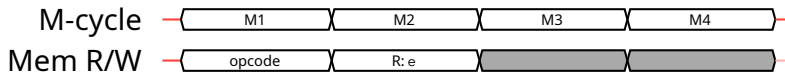

```
opcode = read_memory(addr=PC); PC = PC + 1
if opcode == 0xE8:
    e = signed_8(read_memory(addr=PC)); PC = PC + 1
    result, carry_per_bit = SP + e
    SP = result
    flags.Z = 0
    flags.N = 0
    flags.H = 1 if carry_per_bit[3] else 0
    flags.C = 1 if carry_per_bit[7] else 0
```

Detailed timing and pseudocode

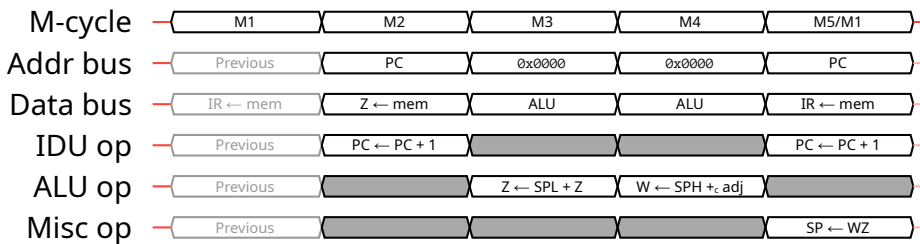

```
# M2
if IR == 0xE8:
    Z = read_memory(addr=PC); PC = PC + 1
# M3
result, carry_per_bit = lsb(SP) + Z
Z = result
flags.Z = 0
flags.N = 0
flags.H = 1 if carry_per_bit[3] else 0
flags.C = 1 if carry_per_bit[7] else 0
# M4
result = msb(SP) + adj + flags.C
W = result
# M5/M1
IR, intr = fetch_cycle(addr=PC); PC = PC + 1; SP = WZ
```

6.6 Rotate, shift, and bit operation instructions

RLCA: Rotate left circular (accumulator)

TODO

Opcode 0b00000111/0x07

Length 1 byte: opcode

Simple timing and pseudocode

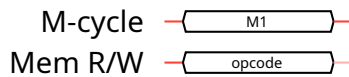

Duration 1 machine cycle

Flags Z = 0, N = 0, H = 0, C = ★

Detailed timing and pseudocode

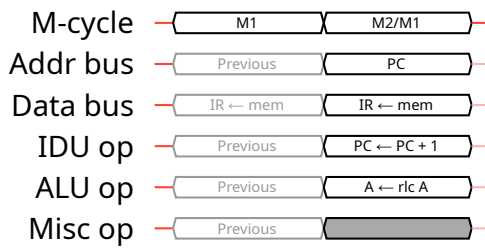

TODO

RRCA: Rotate right circular (accumulator)

TODO

Opcode 0b00001111/0x0F

Length 1 byte: opcode

Simple timing and pseudocode

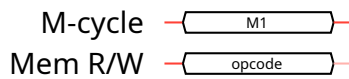

Duration 1 machine cycle

Flags Z = 0, N = 0, H = 0, C = ★

Detailed timing and pseudocode

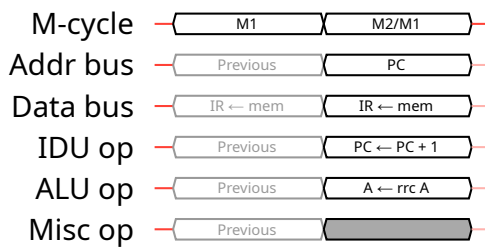

TODO

RLA: Rotate left (accumulator)

TODO

Opcode 0b00010111/0x17

Length 1 byte: opcode

Simple timing and pseudocode

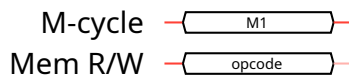

Duration 1 machine cycle

Flags Z = 0, N = 0, H = 0, C = ★

Detailed timing and pseudocode

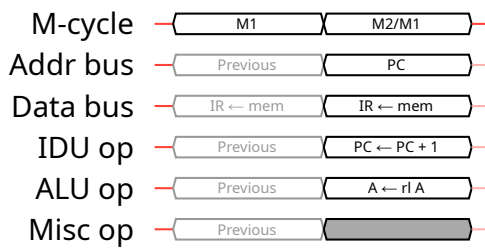

TODO

RRA: Rotate right (accumulator)

TODO

Opcode 0b00011111/0x1F

Length 1 byte: opcode

Simple timing and pseudocode

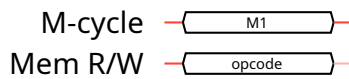

Duration 1 machine cycle

Flags Z = 0, N = 0, H = 0, C = ★

Detailed timing and pseudocode

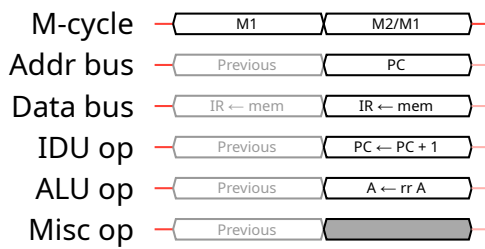

TODO

RLC r: Rotate left circular (register)

TODO

Opcode 0b00000xxx/variou

Length 2 bytes: CB prefix + opcode

Simple timing and pseudocode

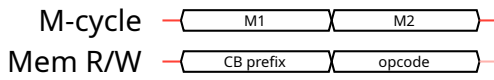

Duration 2 machine cycles

Flags Z = ★, N = 0, H = 0, C = ★

Detailed timing and pseudocode

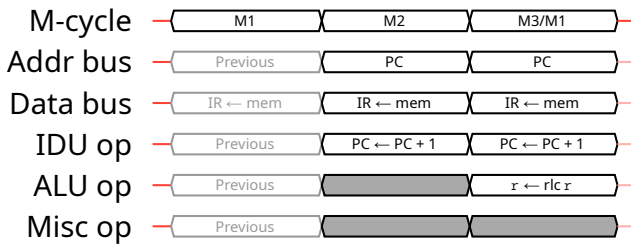

TODO

RLC (HL): Rotate left circular (indirect HL)

TODO

Opcode 0x06

Duration 4 machine cycles

Length 2 bytes: CB prefix + opcode

Flags Z = ★, N = 0, H = 0, C = ★

Simple timing and pseudocode

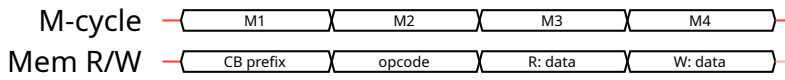

Detailed timing and pseudocode

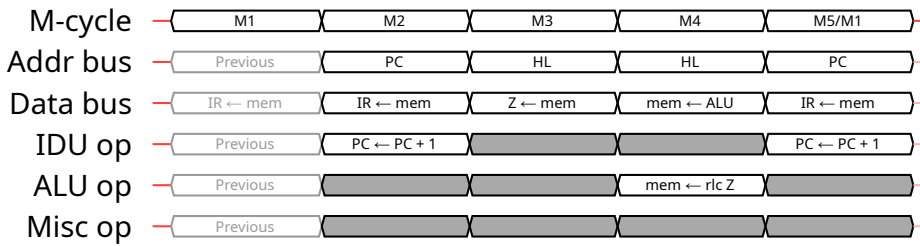

TODO

RRC r: Rotate right circular (register)

TODO

Opcode 0b00001xxx/variou

Length 2 bytes: CB prefix + opcode

Simple timing and pseudocode

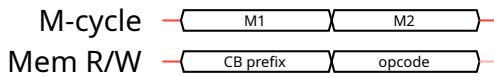

Duration 2 machine cycles

Flags Z = ★, N = 0, H = 0, C = ★

Detailed timing and pseudocode

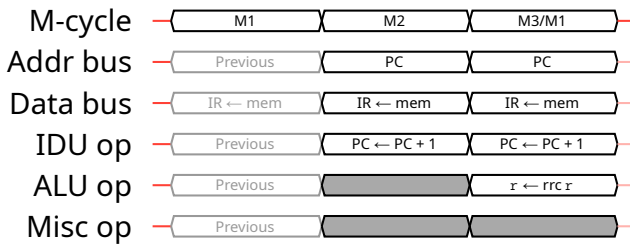

TODO

RRC (HL): Rotate right circular (indirect HL)

TODO

Opcode 0x0E

Duration 4 machine cycles

Length 2 bytes: CB prefix + opcode

Flags Z = ★, N = 0, H = 0, C = ★

Simple timing and pseudocode

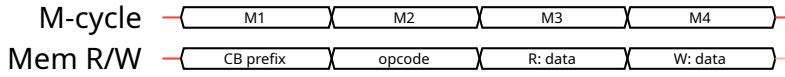

Detailed timing and pseudocode

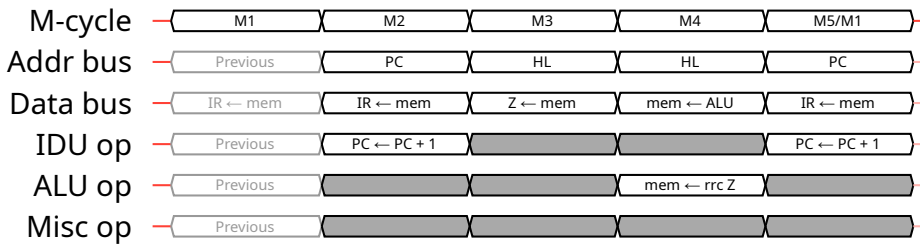

TODO

RL r: Rotate left (register)

TODO

Opcode 0b00010xxx/variou

Length 2 bytes: CB prefix + opcode

Simple timing and pseudocode

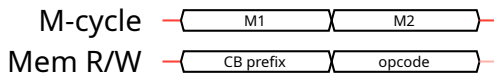

Duration 2 machine cycles

Flags Z = ★, N = 0, H = 0, C = ★

Detailed timing and pseudocode

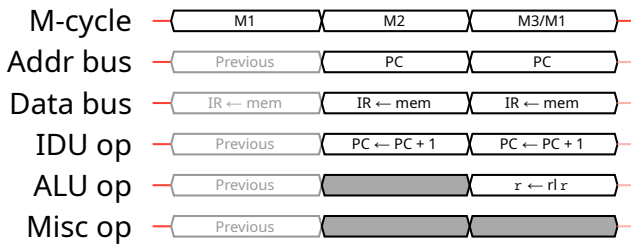

TODO

RL (HL): Rotate left (indirect HL)

TODO

Opcode 0x16

Duration 4 machine cycles

Length 2 bytes: CB prefix + opcode

Flags Z = ★, N = 0, H = 0, C = ★

Simple timing and pseudocode

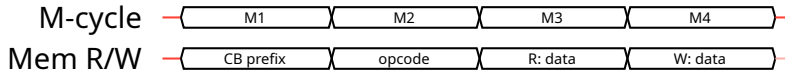

Detailed timing and pseudocode

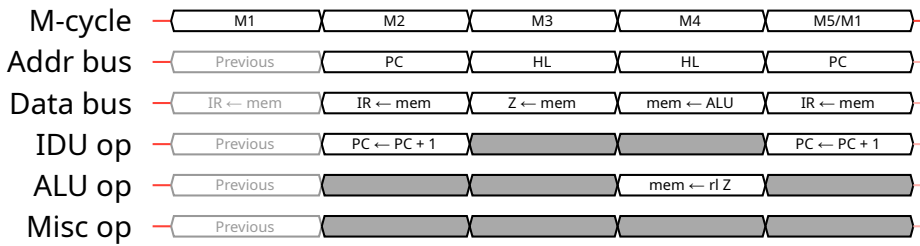

TODO

RR r: Rotate right (register)

TODO

Opcode 0b00011xxx/variou

Length 2 bytes: CB prefix + opcode

Simple timing and pseudocode

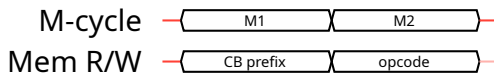

Duration 2 machine cycles

Flags Z = ★, N = 0, H = 0, C = ★

Detailed timing and pseudocode

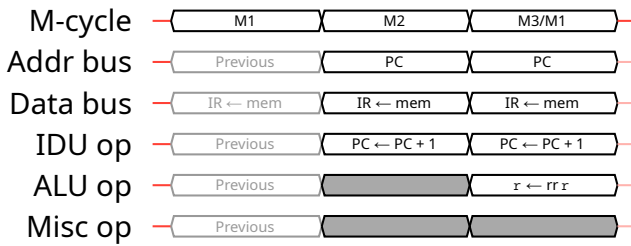

TODO

RR (HL): Rotate right (indirect HL)

TODO

Opcode 0x1E

Duration 4 machine cycles

Length 2 bytes: CB prefix + opcode

Flags Z = ★, N = 0, H = 0, C = ★

Simple timing and pseudocode

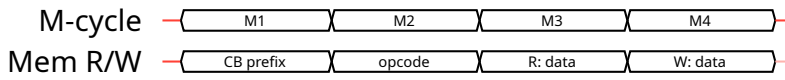

Detailed timing and pseudocode

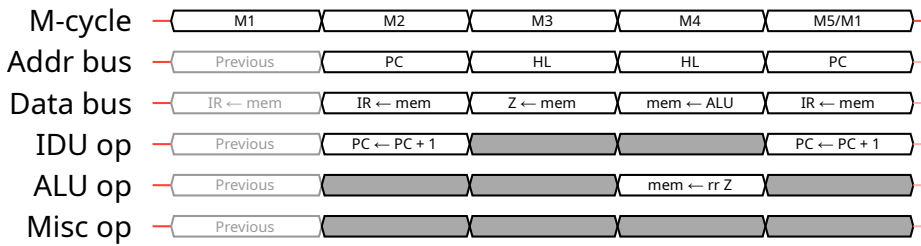

TODO

SLA r: Shift left arithmetic (register)

TODO

Opcode 0b00100xxx/variou

Length 2 bytes: CB prefix + opcode

Simple timing and pseudocode

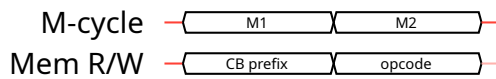

Duration 2 machine cycles

Flags Z = ★, N = 0, H = 0, C = ★

Detailed timing and pseudocode

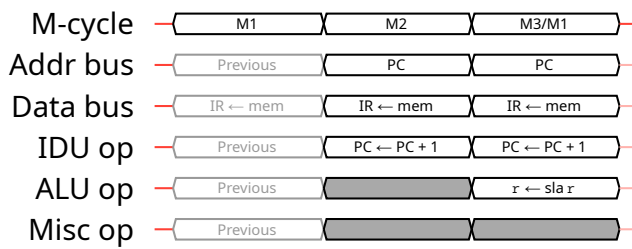

TODO

SLA (HL): Shift left arithmetic (indirect HL)

TODO

Opcode 0x26

Duration 4 machine cycles

Length 2 bytes: CB prefix + opcode

Flags Z = ★, N = 0, H = 0, C = ★

Simple timing and pseudocode

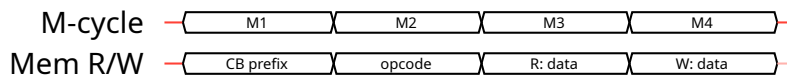

Detailed timing and pseudocode

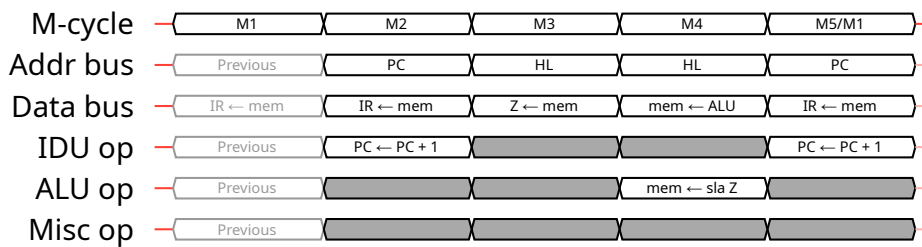

TODO

SRA r: Shift right arithmetic (register)

TODO

Opcode 0b00101xxx/variou

Length 2 bytes: CB prefix + opcode

Simple timing and pseudocode

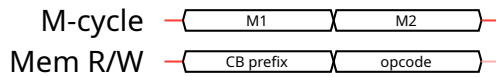

Duration 2 machine cycles

Flags Z = ★, N = 0, H = 0, C = ★

Detailed timing and pseudocode

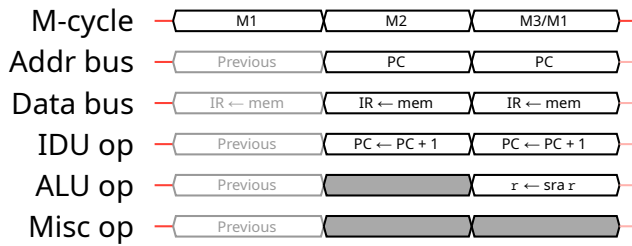

TODO

SRA (HL): Shift right arithmetic (indirect HL)

TODO

Opcode 0x2E

Duration 4 machine cycles

Length 2 bytes: CB prefix + opcode

Flags Z = ★, N = 0, H = 0, C = ★

Simple timing and pseudocode

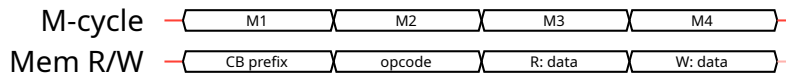

Detailed timing and pseudocode

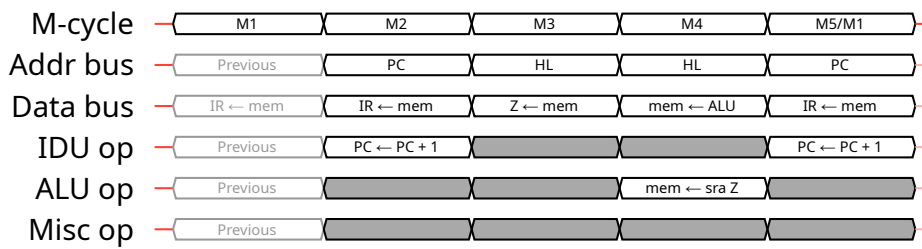

TODO

SWAP r: Swap nibbles (register)

TODO

Opcode 0b00110xxx/variou

Length 2 bytes: CB prefix + opcode

Simple timing and pseudocode

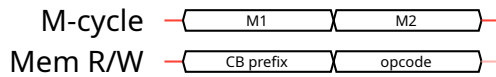

Duration 2 machine cycles

Flags Z = ★, N = 0, H = 0, C = 0

Detailed timing and pseudocode

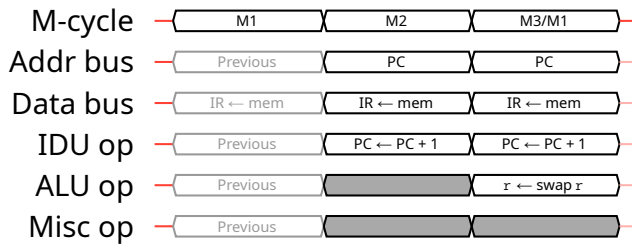

TODO

SWAP (HL): Swap nibbles (indirect HL)

TODO

Opcode 0x36

Duration 4 machine cycles

Length 2 bytes: CB prefix + opcode

Flags Z = ★, N = 0, H = 0, C = 0

Simple timing and pseudocode

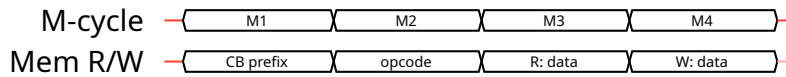

Detailed timing and pseudocode

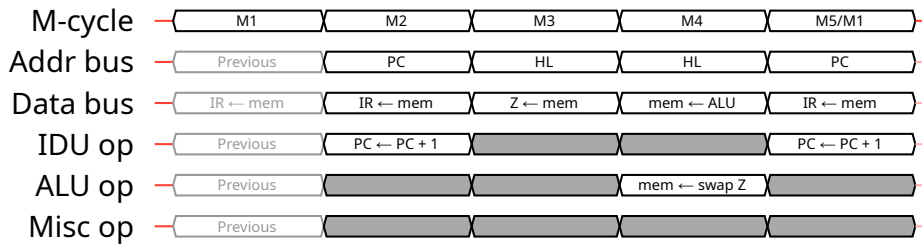

TODO

SRL r: Shift right logical (register)

TODO

Opcode 0b00111xxx/variou

Length 2 bytes: CB prefix + opcode

Simple timing and pseudocode

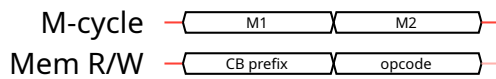

Duration 2 machine cycles

Flags Z = ★, N = 0, H = 0, C = ★

Detailed timing and pseudocode

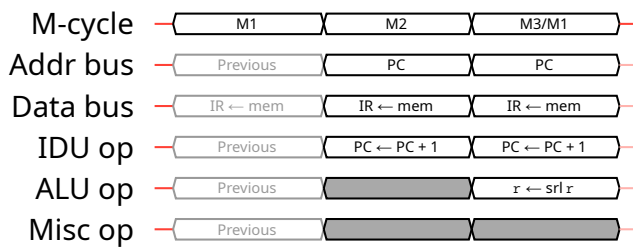

TODO

SRL (HL): Shift right logical (indirect HL)

TODO

Opcode 0x3E

Duration 4 machine cycles

Length 2 bytes: CB prefix + opcode

Flags Z = ★, N = 0, H = 0, C = ★

Simple timing and pseudocode

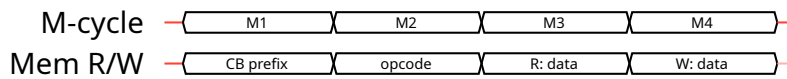

Detailed timing and pseudocode

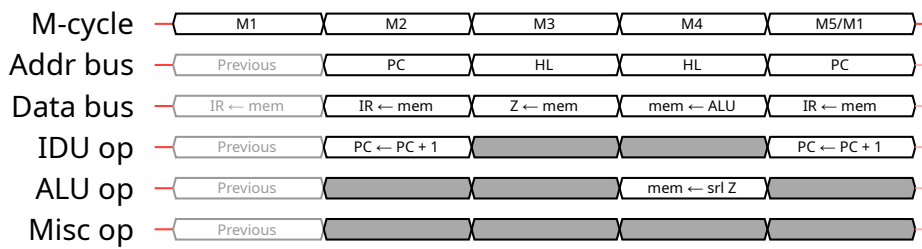

TODO

BIT b, r: Test bit (register)

TODO

Opcode 0b01xxxxxx/varioux

Length 2 bytes: CB prefix + opcode

Simple timing and pseudocode

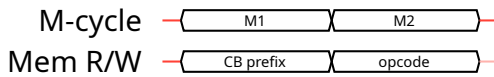

Duration 2 machine cycles

Flags Z = ★, N = 0, H = 1

Detailed timing and pseudocode

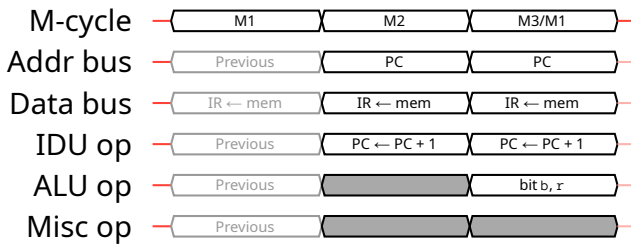

TODO

BIT b, (HL): Test bit (indirect HL)

TODO

Opcode 0b01xxx110/variou

Duration 3 machine cycles

Length 2 bytes: CB prefix + opcode

Flags Z = ★, N = 0, H = 1

Simple timing and pseudocode



Detailed timing and pseudocode

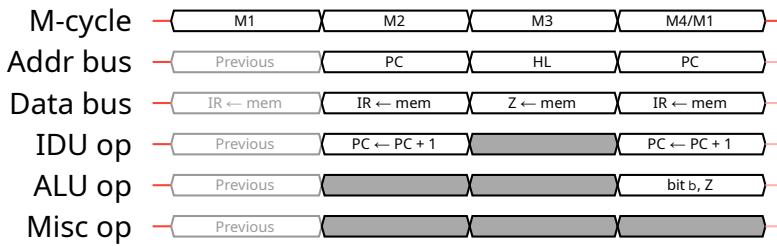

TODO

RES b, r: Reset bit (register)

TODO

Opcode 0b10xxxxxxx/varioux

Length 2 bytes: CB prefix + opcode

Simple timing and pseudocode

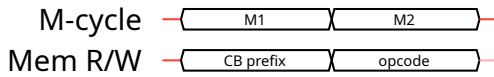

Duration 2 machine cycles

Flags -

Detailed timing and pseudocode

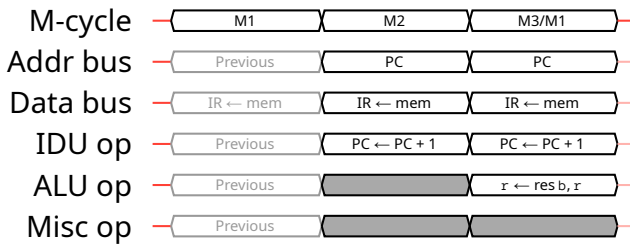

TODO

RES b, (HL): Reset bit (indirect HL)

TODO

Opcode 0b10xxx110/variou

Duration 4 machine cycles

Length 2 bytes: CB prefix + opcode

Flags -

Simple timing and pseudocode

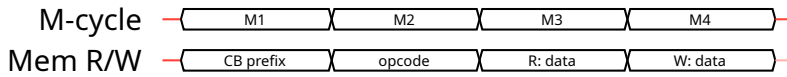

Detailed timing and pseudocode

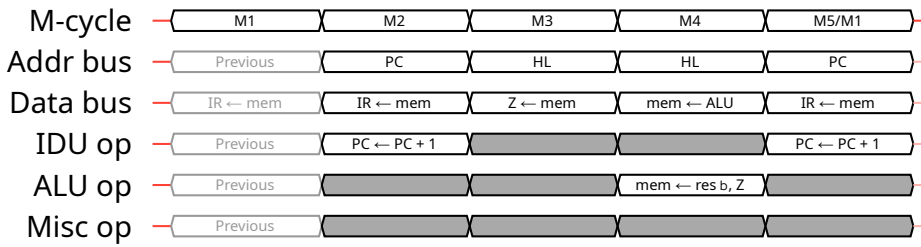

TODO

SET b, r: Set bit (register)

TODO

Opcode 0b11xxxxxx/varioux

Length 2 bytes: CB prefix + opcode

Simple timing and pseudocode

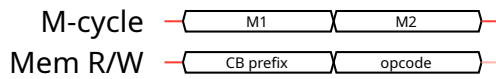

Duration 2 machine cycles

Flags -

Detailed timing and pseudocode

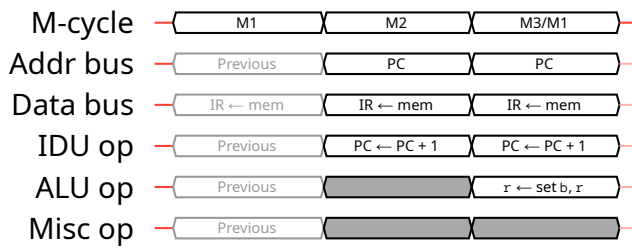

TODO

SET b, (HL): Set bit (indirect HL)

TODO

Opcode 0b11xxx110/variou

Duration 4 machine cycles

Length 2 bytes: CB prefix + opcode

Flags -

Simple timing and pseudocode

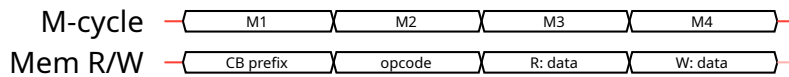

Detailed timing and pseudocode

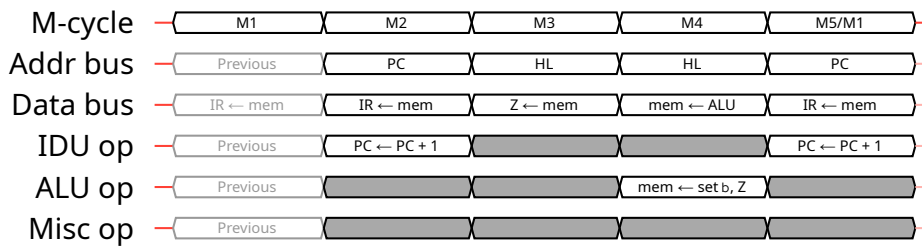

TODO

6.7 Control flow instructions

JP nn: Jump

Unconditional jump to the absolute address specified by the 16-bit immediate operand nn.

Opcode 0b11000011/0xC3

Duration 4 machine cycles

Length 3 bytes: opcode + LSB(nn) + MSB(nn) **Flags** -

Simple timing and pseudocode

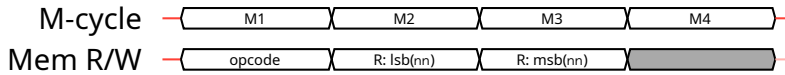

```
opcode = read_memory(addr=PC); PC = PC + 1
```

```
if opcode == 0xC3:
```

```
    nn_lsb = read_memory(addr=PC); PC = PC + 1
```

```
    nn_msb = read_memory(addr=PC); PC = PC + 1
```

```
    nn = unsigned_16(lsb=nn_lsb, msb=nn_msb)
```

```
    PC = nn
```

Detailed timing and pseudocode

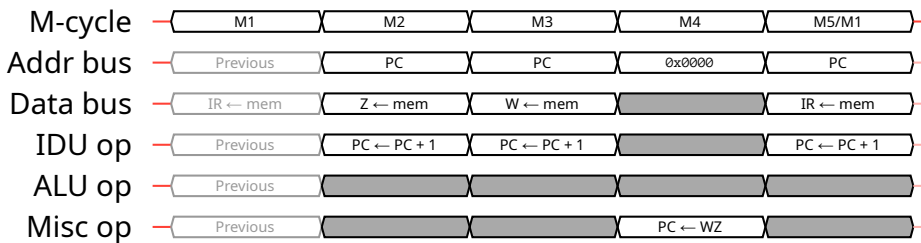

```
# M2
```

```
if IR == 0xC3:
```

```
    Z = read_memory(addr=PC); PC = PC + 1
```

```
    # M3
```

```
    W = read_memory(addr=PC); PC = PC + 1
```

```
    # M4
```

```
    PC = WZ
```

```
    # M5/M1
```

```
    IR, intr = fetch_cycle(addr=PC); PC = PC + 1
```

JP HL: Jump to HL

Unconditional jump to the absolute address specified by the 16-bit register HL.

Opcode 0b111101001/0xE9

Duration 1 machine cycle

Length 1 byte: opcode

Flags -

Simple timing and pseudocode

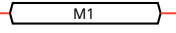
M-cycle 

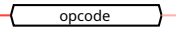
Mem R/W 

```
opcode = read_memory(addr=PC); PC = PC + 1
```

```
if opcode == 0xE9:
```

```
    PC = HL
```

Detailed timing and pseudocode

M-cycle 

Addr bus 

Data bus 

IDU op 

ALU op 

Misc op 

M2/M1

```
if IR == 0xE9:
```

```
    IR, intr = fetch_cycle(addr=HL); PC = HL + 1
```

Warning

In some documentation this instruction is written as `JP [HL]`. This is very misleading, since brackets are usually used to indicate a memory read, and this instruction simply copies the value of HL to PC.

JP cc, nn: Jump (conditional)

Conditional jump to the absolute address specified by the 16-bit operand `nn`, depending on the condition `cc`.

Note that the operand (absolute address) is read even when the condition is false!

Opcode `0b110xx010/variables`

Duration 4 machine cycles (`cc=true`)
3 machine cycles (`cc=false`)

Length 3 bytes: opcode + LSB(`nn`) + MSB(`nn`)

Flags -

Simple timing and pseudocode

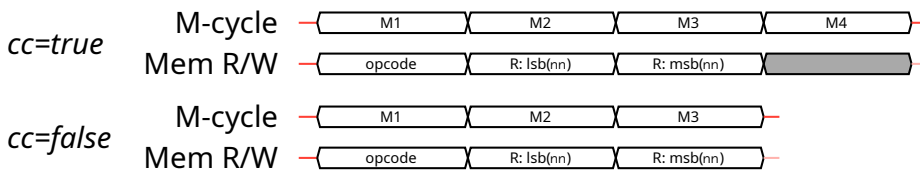

```
opcode = read_memory(addr=PC); PC = PC + 1
```

```
if opcode == 0xC2: # example: JP NZ, nn
```

```
    nn_lsb = read_memory(addr=PC); PC = PC + 1
```

```
    nn_msb = read_memory(addr=PC); PC = PC + 1
```

```
    nn = unsigned_16(lsb=nn_lsb, msb=nn_msb)
```

```
    if !flags.Z: # cc=true
```

```
        PC = nn
```

Detailed timing and pseudocode

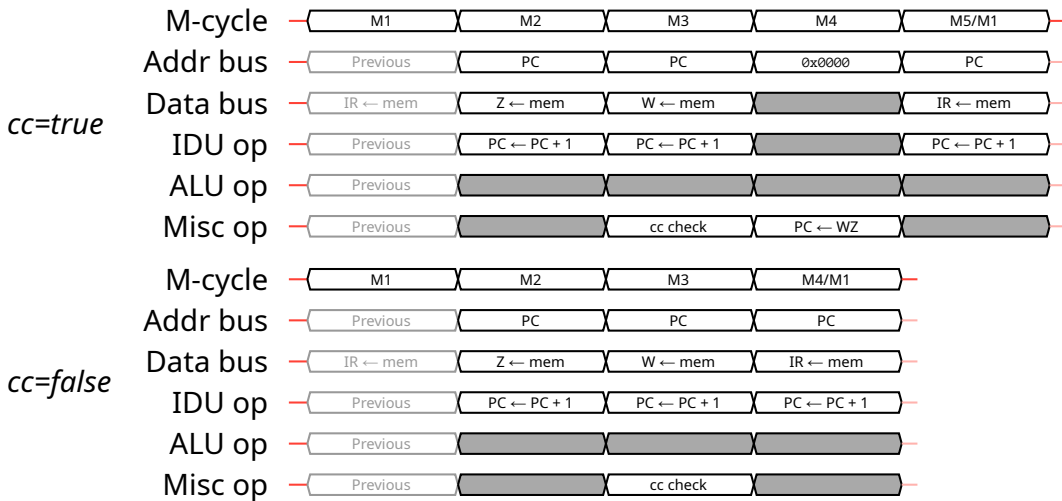

```

# M2
if IR == 0xC2: # example: JP NZ, nn
    Z = read_memory(addr=PC); PC = PC + 1
# M3
    W = read_memory(addr=PC); PC = PC + 1
    if !flags.Z: # cc=true
# M4
        PC = WZ
# M5/M1
        IR, intr = fetch_cycle(addr=PC); PC = PC + 1
else: # cc=false
# M4/M1
    IR, intr = fetch_cycle(addr=PC); PC = PC + 1

```

JR e: Relative jump

Unconditional jump to the relative address specified by the signed 8-bit operand e.

Opcode 0b00011000/0x18

Duration 3 machine cycles

Length 2 bytes: opcode + e

Flags -

Simple timing and pseudocode



```
opcode = read_memory(addr=PC); PC = PC + 1
```

```
if opcode == 0x18:
```

```
    e = signed_8(read_memory(addr=PC)); PC = PC + 1
```

```
    PC = PC + e
```

Detailed timing and pseudocode

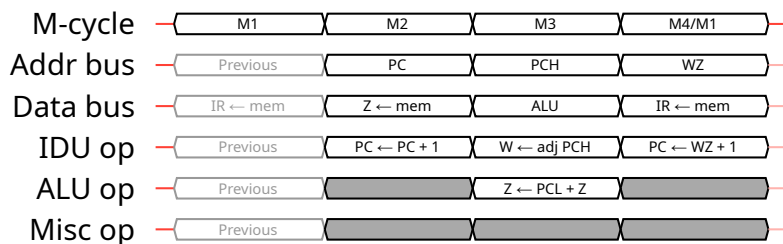

```
# M2
```

```
if IR == 0x18:
```

```
    Z = read_memory(addr=PC); PC = PC + 1
```

```
    # M3
```

```
    Z_sign = bit(7, Z)
```

```
    result, carry_per_bit = Z + lsb(PC)
```

```
    Z = result
```

```
    adj = 1 if carry_per_bit[7] and not Z_sign else  
          -1 if not carry_per_bit[7] and Z_sign else  
          0
```

```
    W = msb(PC) + adj
```

```
    # M4/M1
```

```
    IR, intr = fetch_cycle(addr=WZ); PC = WZ + 1
```

JR cc, e: Relative jump (conditional)

Conditional jump to the relative address specified by the signed 8-bit operand *e*, depending on the condition *cc*.

Note that the operand (relative address offset) is read even when the condition is false!

Opcode `0b001xx000/variables`

Duration 3 machine cycles (*cc*=true)
2 machine cycles (*cc*=false)

Length 2 bytes: opcode + *e*

Flags -

Simple timing and pseudocode

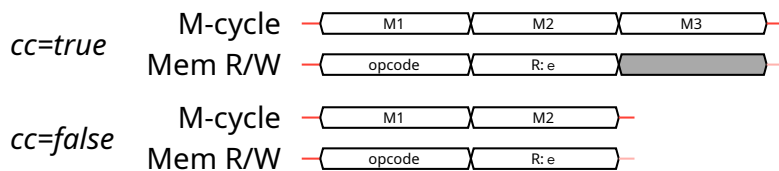

```
opcode = read_memory(addr=PC); PC = PC + 1
```

```
if opcode == 0x20:
```

```
    e = signed_8(read_memory(addr=PC)); PC = PC + 1
```

```
    if !flags.Z: # cc=true
```

```
        PC = PC + e
```

Detailed timing and pseudocode

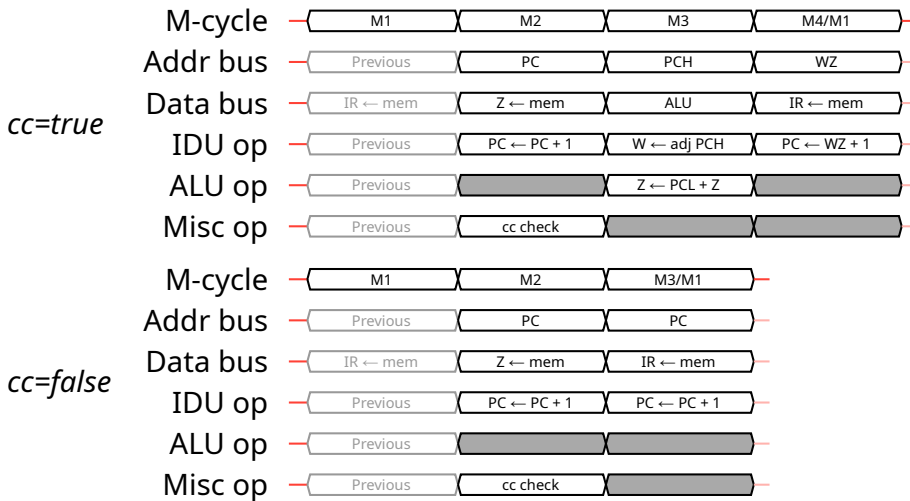

```

# M2
if IR == 0x20:
    Z = read_memory(addr=PC); PC = PC + 1
    if !flags.Z: # cc=true
        # M3
        Z_sign = bit(7, Z)
        result, carry_per_bit = Z + lsb(PC)
        Z = result
        adj = 1 if carry_per_bit[7] and not Z_sign else
              -1 if not carry_per_bit[7] and Z_sign else
              0
        W = msb(PC) + adj
        # M4/M1
        IR, intr = fetch_cycle(addr=WZ); PC = WZ + 1
    else: # cc=false
        # M3/M1
        IR, intr = fetch_cycle(addr=PC); PC = PC + 1

```

CALL nn: Call function

Unconditional function call to the absolute address specified by the 16-bit operand nn.

Opcode 0b11001101/0xCD

Duration 6 machine cycles

Length 3 bytes: opcode + LSB(nn) + MSB(nn) **Flags** -

Simple timing and pseudocode

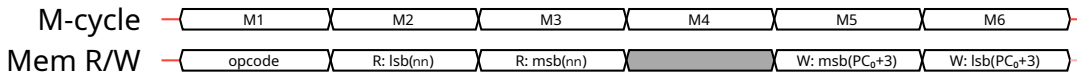

```
opcode = read_memory(addr=PC); PC = PC + 1
if opcode == 0xCD:
    nn_lsb = read_memory(addr=PC); PC = PC + 1
    nn_msb = read_memory(addr=PC); PC = PC + 1
    nn = unsigned_16(lsb=nn_lsb, msb=nn_msb)
    SP = SP - 1
    write_memory(addr=SP, data=msb(PC)); SP = SP - 1
    write_memory(addr=SP, data=lsb(PC))
    PC = nn
```

Detailed timing and pseudocode

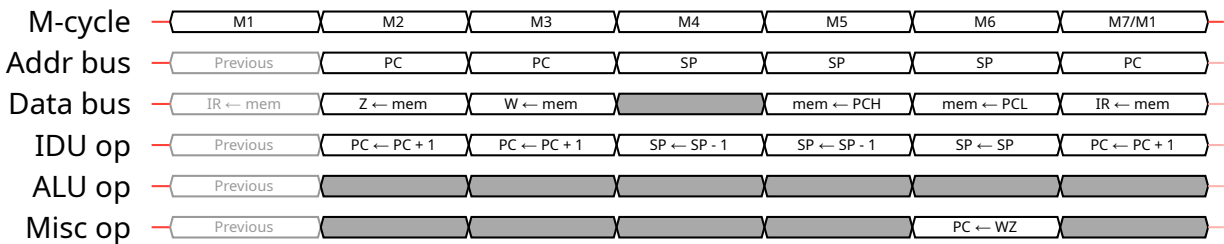

```
# M2
if IR == 0xCD:
    Z = read_memory(addr=PC); PC = PC + 1
# M3
    W = read_memory(addr=PC); PC = PC + 1
# M4
    SP = SP - 1
# M5
    write_memory(addr=SP, data=msb(PC)); SP = SP - 1
# M6
    write_memory(addr=SP, data=lsb(PC)); PC = WZ
# M7/M1
    IR, intr = fetch_cycle(addr=PC); PC = PC + 1
```

CALL cc, nn: Call function (conditional)

Conditional function call to the absolute address specified by the 16-bit operand nn, depending on the condition cc.

Note that the operand (absolute address) is read even when the condition is false!

Opcode 0b110xx100/variou

Duration 6 machine cycles (cc=true)
3 machine cycles (cc=false)

Length 3 bytes: opcode + LSB(nn) + MSB(nn) **Flags** -

Simple timing and pseudocode



```
opcode = read_memory(addr=PC); PC = PC + 1
if opcode == 0xC4: # example: CALL NZ, nn
    nn_lsb = read_memory(addr=PC); PC = PC + 1
    nn_msb = read_memory(addr=PC); PC = PC + 1
    nn = unsigned_16(lsb=nn_lsb, msb=nn_msb)
    if !flags.Z: # cc=true
        SP = SP - 1
        write_memory(addr=SP, data=msb(PC)); SP = SP - 1
        write_memory(addr=SP, data=lsb(PC))
    PC = nn
```

Detailed timing and pseudocode

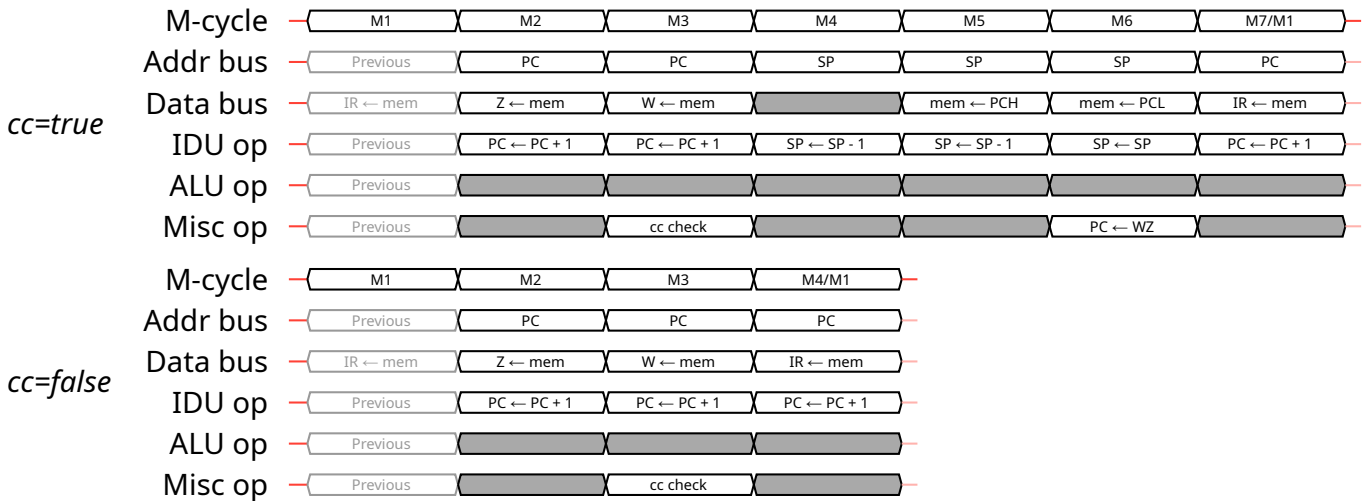

```

# M2
if IR == 0xC4: # example: CALL NZ, nn
    Z = read_memory(addr=PC); PC = PC + 1
# M3
    W = read_memory(addr=PC); PC = PC + 1
    if !flags.Z: # cc=true
# M4
        SP = SP - 1
# M5
        write_memory(addr=SP, data=msb(PC)); SP = SP - 1
# M6
        write_memory(addr=SP, data=lsb(PC)); PC = WZ
# M7/M1
        IR, intr = fetch_cycle(addr=PC); PC = PC + 1
else: # cc=false
# M4/M1
    IR, intr = fetch_cycle(addr=PC); PC = PC + 1

```

RET: Return from function

Unconditional return from a function.

Opcode 0b11001001/0xC9

Duration 4 machine cycles

Length 1 byte: opcode

Flags -

Simple timing and pseudocode

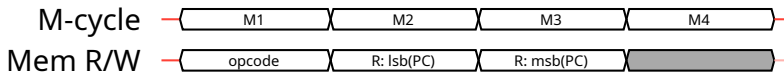

```
opcode = read_memory(addr=PC); PC = PC + 1
if opcode == 0xC9:
    lsb = read_memory(addr=SP); SP = SP + 1
    msb = read_memory(addr=SP); SP = SP + 1
    PC = unsigned_16(lsb=lsb, msb=msb)
```

Detailed timing and pseudocode

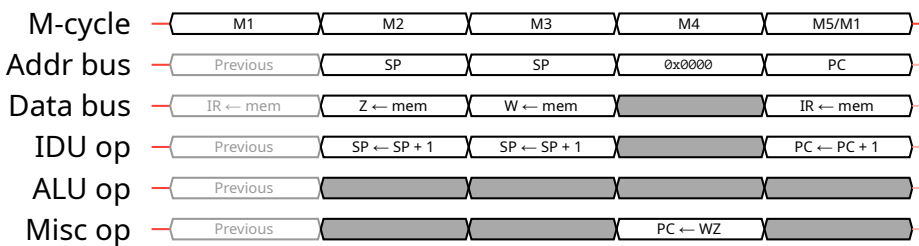

```
# M2
if IR == 0xC9:
    Z = read_memory(addr=SP); SP = SP + 1
# M3
    W = read_memory(addr=SP); SP = SP + 1
# M4
    PC = WZ
# M5/M1
    IR, intr = fetch_cycle(addr=PC); PC = PC + 1
```

RET cc: Return from function (conditional)

Conditional return from a function, depending on the condition cc.

Opcode 0b110xx000/various

Duration 5 machine cycles (cc=true)
2 machine cycles (cc=false)

Length 1 byte: opcode

Flags -

Simple timing and pseudocode

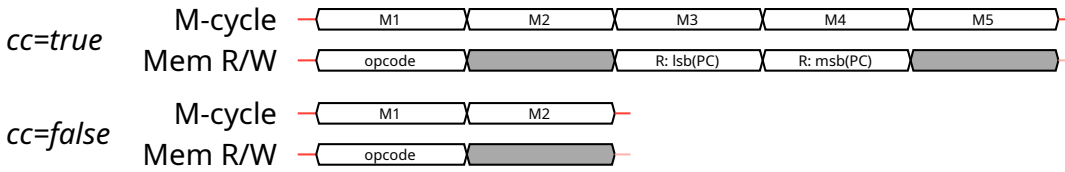

opcode = read_memory(addr=PC); PC = PC + 1

if opcode == 0xC0: # example: RET NZ

if !flags.Z: # cc=true

lsb = read_memory(addr=SP); SP = SP + 1

msb = read_memory(addr=SP); SP = SP + 1

PC = unsigned_16(lsb=lsb, msb=msb)

Detailed timing and pseudocode

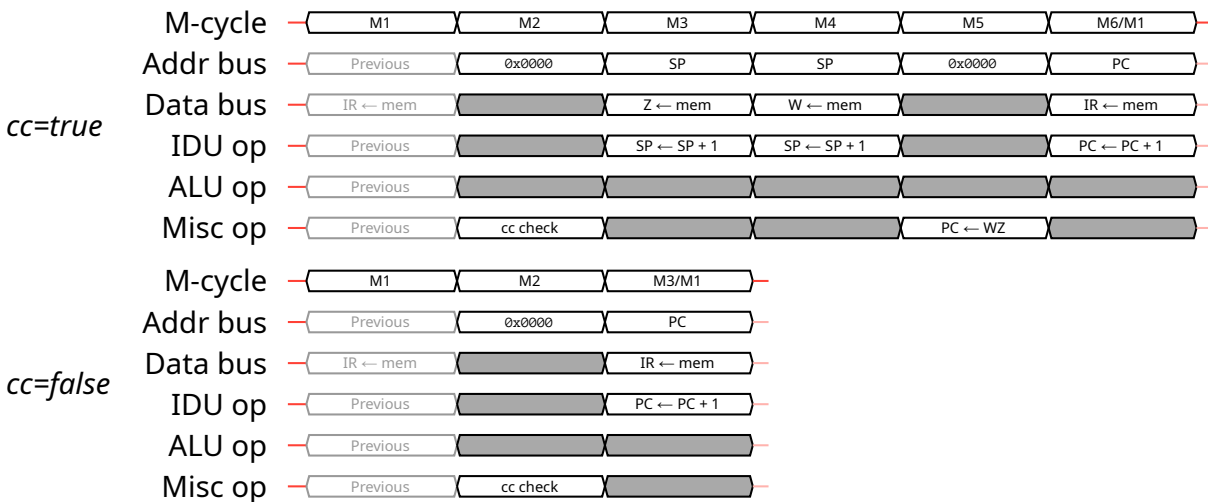

M2

if IR == 0xC0: # example: RET NZ

if !flags.Z: # cc=true

M3

Z = read_memory(addr=SP); SP = SP + 1

M4

W = read_memory(addr=SP); SP = SP + 1

M5

PC = WZ

M6/M1

IR, intr = fetch_cycle(addr=PC); PC = PC + 1

else: # cc=false

M3

IR, intr = fetch_cycle(addr=PC); PC = PC + 1

RETI: Return from interrupt handler

Unconditional return from a function. Also enables interrupts by setting IME=1.

Opcode 0b11011001/0xD9

Duration 4 machine cycles

Length 1 byte: opcode

Flags -

Simple timing and pseudocode

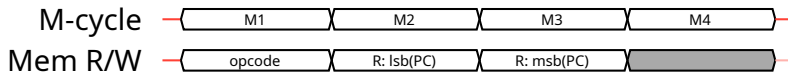

```
opcode = read_memory(addr=PC); PC = PC + 1
```

```
if opcode == 0xD9:
```

```
    lsb = read_memory(addr=SP); SP = SP + 1
```

```
    msb = read_memory(addr=SP); SP = SP + 1
```

```
    PC = unsigned_16(lsb=lsb, msb=msb)
```

```
    IME = 1
```

Detailed timing and pseudocode

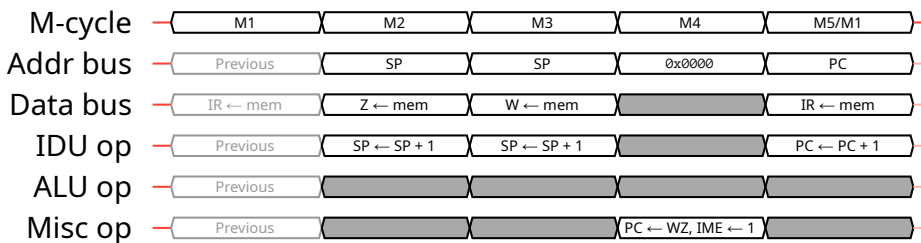

```
# M2
```

```
if IR == 0xD9:
```

```
    Z = read_memory(addr=SP); SP = SP + 1
```

```
# M3
```

```
    W = read_memory(addr=SP); SP = SP + 1
```

```
# M4
```

```
    PC = WZ; IME = 1
```

```
# M5/M1
```

```
    IR, intr = fetch_cycle(addr=PC); PC = PC + 1
```

RST n: Restart / Call function (implied)

Unconditional function call to the absolute fixed address defined by the opcode.

Opcode 0b11xxx111/various

Duration 4 machine cycles

Length 1 byte: opcode

Flags -

Simple timing and pseudocode

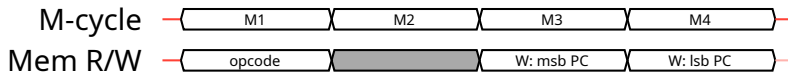

```
opcode = read_memory(addr=PC); PC = PC + 1
```

```
if opcode == 0xDF: # example: RST 0x18
```

```
  n = 0x18
```

```
  SP = SP - 1
```

```
  write_memory(addr=SP, data=msb(PC)); SP = SP - 1
```

```
  write_memory(addr=SP, data=lsb(PC))
```

```
  PC = unsigned_16(lsb=n, msb=0x00)
```

Detailed timing and pseudocode

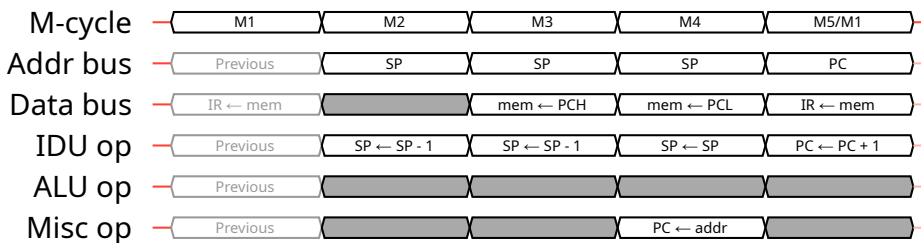

```
# M2
```

```
if IR == 0xDF: # example: RST 0x18
```

```
  SP = SP - 1
```

```
  # M3
```

```
  write_memory(addr=SP, data=msb(PC)); SP = SP - 1
```

```
  # M4
```

```
  write_memory(addr=SP, data=lsb(PC)); PC = 0x0018
```

```
  # M5/M1
```

```
  IR, intr = fetch_cycle(addr=PC); PC = PC + 1
```

6.8 Miscellaneous instructions

HALT: Halt system clock

TODO

STOP: Stop system and main clocks

TODO

DI: Disable interrupts

Disables interrupt handling by setting IME=0 and cancelling any scheduled effects of the EI instruction if any.

Opcode 0b11110011/0xF3

Duration 1 machine cycle

Length 1 byte: opcode

Flags -

Simple timing and pseudocode

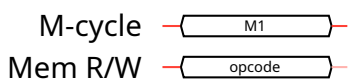

```
opcode = read_memory(addr=PC); PC = PC + 1
```

```
if opcode == 0xF3:
```

```
    IME = 0
```

Detailed timing and pseudocode

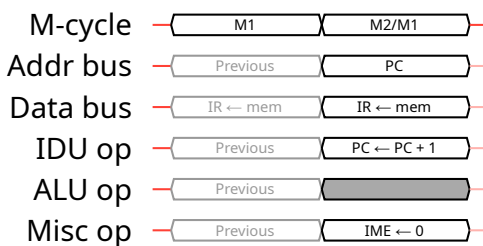

```
# M2/M1
```

```
if IR == 0xF3:
```

```
    # interrupt checking is suppressed so fetch_cycle(..) is not used
```

```
    IR = read_memory(addr=PC); PC = PC + 1; IME = 0
```

EI: Enable interrupts

Schedules interrupt handling to be enabled after the next machine cycle.

Opcode 0b11111011/0xFB

Duration 1 machine cycle

Length 1 byte: opcode

Flags -

Simple timing and pseudocode

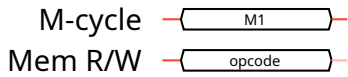

```
opcode = read_memory(addr=PC); PC = PC + 1  
if opcode == 0xFB:  
    IME_next = 1
```

Detailed timing and pseudocode

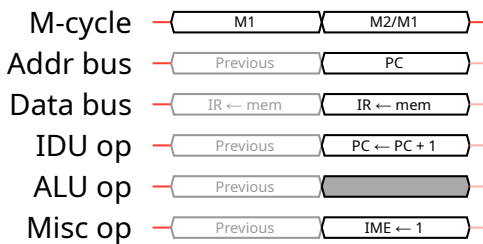

M2/M1

```
if IR == 0xFB:  
    IR, intr = fetch_cycle(addr=PC); PC = PC + 1; IME = 1
```

NOP: No operation

No operation. This instruction doesn't do anything, but can be used to add a delay of one machine cycle and increment PC by one.

Opcode 0b00000000/0x00

Duration 1 machine cycle

Length 1 byte: opcode

Flags -

Simple timing and pseudocode

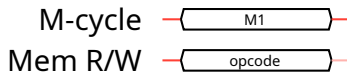

```
opcode = read_memory(addr=PC); PC = PC + 1
```

```
if opcode == 0x00:
```

```
    # nothing
```

Detailed timing and pseudocode

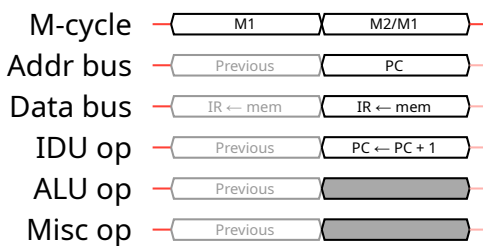

```
# M2/M1
```

```
if IR == 0x00:
```

```
    IR, intr = fetch_cycle(addr=PC); PC = PC + 1
```

Part III

Game Boy SoC peripherals and features

Chapter 7

Boot ROM

The Game Boy SoC includes a small embedded boot ROM, which can be mapped to the `0x0000-0x00FF` memory area. While mapped, all reads from this area are handled by the boot ROM instead of the external cartridge, and all writes to this area are ignored and cannot be seen by external hardware (e.g. the cartridge MBC).

The boot ROM is enabled by default, so when the system exits the reset state and the CPU starts execution from address `0x0000`, it executes the boot ROM instead of instructions from the cartridge ROM. The boot ROM is responsible for showing the initial logo, and checking that a valid cartridge is inserted into the system. If the cartridge is valid, the boot ROM unmaps itself before execution of the cartridge ROM starts at `0x0100`. The cartridge ROM has no chance of executing any instructions before the boot ROM is unmapped, which prevents the boot ROM from being read byte by byte in normal conditions.

Warning

Don't confuse the boot ROM with the additional SNES ROM in SGB/SGB2 that is executed by the SNES CPU.

Register 7.1: `0xFF50` - BOOT - Boot ROM lock register

U	U	U	U	U	U	U	R/W-0
							BOOT_OFF
bit 7	6	5	4	3	2	1	bit 0

bit 7-1 Unimplemented: Ignored during writes, reads are undefined

bit 0 BOOT_OFF: Boot ROM lock bit

`0b1` = Boot ROM is disabled and `0x0000-0x00FF` works normally.

`0b0` = Boot ROM is active and intercepts accesses to `0x0000-0x00FF`.

BOOT_OFF can only transition from `0b0` to `0b1`, so once `0b1` has been written, the boot ROM is permanently disabled until the next system reset. Writing `0b0` when BOOT_OFF is `0b0` has no effect and doesn't lock the boot ROM.

The 1-bit BOOT register controls mapping of the boot ROM. Once `0b1` has been written to it to unmap the boot ROM, it can only be mapped again by resetting the system.

7.1 Boot ROM types

Type	CRC32	MD5	SHA1
DMG	59c8598e	32fbbd84168d3482956eb3c5051637f5	4ed31ec6b0b175bb109c0eb5fd3d193da823339f
MGB	e6920754	71a378e71ff30b2d8a1f02bf5c7896aa	4e68f9da03c310e84c523654b9026e51f26ce7f0
SGB	ec8a83b9	d574d4f9c12f305074798f54c091a8b4	aa2f50a77dfb4823da96ba99309085a3c6278515
SGB2	53d0dd63	e0430bca9925fb9882148fd2dc2418c1	93407ea10d2f30ab96a314d8eca44fe160aea734
DMG0	c2f5cc97	a8f84a0ac44da5d3f0ee19f9cea80a8c	8bd501e31921e9601788316dbd3ce9833a97bcbc

Table 7.1: Summary of boot ROM file hashes

DMG boot ROM

The most common boot ROM is the DMG boot ROM used in almost all original Game Boy units. If a valid cartridge is inserted, the boot ROM scrolls a logo to the center of the screen, and plays a “di-ding” sound recognizable by most people who have used Game Boy consoles.

This boot ROM was originally dumped by neviksti in 2003 by decapping the Game Boy SoC and visually inspecting every single bit.

MGB boot ROM

This boot ROM was originally dumped by Bennvenn in 2014 by using a simple clock glitching method that only requires one wire.

SGB boot ROM

This boot ROM was originally dumped by Costis Sideris in 2009 by using an FPGA-based clock glitching method [4].

SGB2 boot ROM

This boot ROM was originally dumped by gekkio in 2015 by using a Teensy 3.1 -based clock glitching method [5].

Early DMG boot ROM (“DMG0”)

Very early original Game Boy units released in Japan (often called “DMG0”) included the launch version “DMG-CPU” SoC chip, which used a different boot ROM than later units.

This boot ROM was originally dumped by gekkio in 2016 by using a clock glitching method invented by BennVenn.

Chapter 8

DMA (Direct Memory Access)

8.1 Object Attribute Memory (OAM) DMA

OAM DMA is a high-throughput mechanism for copying data to the OAM area (a.k.a. Object Attribute Memory, a.k.a. sprite memory). It can copy one byte per machine cycle without involving the CPU at all, which is much faster than the fastest possible memcopy routine that can be written with the SM83 instruction set. However, a transfer cannot be cancelled and the transfer length cannot be controlled, so the DMA transfer always updates the entire OAM area (= 160 bytes) even if you actually want to just update the first couple of bytes.

The Game Boy CPU chip contains a DMA controller that coordinates transfers between a **source area** and the **OAM area** independently of the CPU. While a transfer is in progress, it takes control of the source bus and the OAM area, so some precaution is needed with memory accesses (including instruction fetches) to avoid OAM DMA bus conflicts. OAM DMA uses a different address decoding scheme than normal memory accesses, so the source bus is always either the external bus or the video RAM bus, and the contents normally visible to the CPU in the 0xFE00-0xFFFF address range cannot be used as a source for OAM DMA transfers.

The upper 8 bits of the OAM DMA source address are stored in the DMA register, while the lower 8 bits used by both the source and target address are stored in the DMA controller and are not accessible directly. A transfer always begins with 0x00 in the lower bits and copies exactly 160 bytes, so the lower bits are never in the 0xA0-0xFF range.

Writing to the DMA register updates the upper bits of the DMA source address and also triggers an OAM DMA transfer request, although the DMA transfer does not begin immediately.

Register 8.1: 0xFF46 - DMA - OAM DMA control register

R/W-x	R/W-x	R/W-x	R/W-x	R/W-x	R/W-x	R/W-x	R/W-x
DMA<7:0>							
bit 7	6	5	4	3	2	1	bit 0

bit 7-0 DMA<7:0>: OAM DMA source address
Specifies the top 8 bits of the OAM DMA source address.

Writing to this register requests an OAM DMA transfer, but it's just a request and the actual DMA transfer starts with a delay.

Reading this register returns the value that was previously written to the register. The stored value is not cleared on reset, so the initial value before the first write is unknown and should not be relied on.

Warning

Avoid writing 0xE0-0xFF to the DMA register, because some poorly designed flash carts can trigger bus conflicts or other dangerous behaviour.

OAM DMA address decoding

The OAM DMA controller uses a simplified address decoding scheme, which leads to some addresses being unusable as source addresses. Unlike normal memory accesses, OAM DMA transfers interpret all accesses in the $0xA000-0xFFFF$ range as external RAM transfers. For example, if the OAM DMA wants to read $0xFF00$, it will output $0xFF00$ on the external address bus and will assert the external RAM chip select signal. The P1 register which is normally at $0xFF00$ is not involved at all, because OAM DMA address decoding only uses the external bus and the video RAM bus. Instead, the resulting behaviour depends on several factors, including the connected cartridge. Some flash carts are not prepared for this unexpected scenario, and a bus conflict or worse behaviour can happen.

DMA register value	Used bus	Asserted chip select signal
$0x00-0x7F$	external bus	external ROM (A15)
$0x80-0x9F$	video RAM bus	video RAM (MCS)
$0xA0-0xFF$	external bus	external RAM (CS)

Table 8.1: OAM DMA address decoding scheme

OAM DMA transfer timing

TODO

OAM DMA bus conflicts

TODO

Chapter 9

PPU (Picture Processing Unit)

Register 9.1: 0xFF40 - LCDC - PPU control register

R/W-0	R/W-0	R/W-0	R/W-0	R/W-0	R/W-0	R/W-0	R/W-0
LCD_EN	WIN_MAP	WIN_EN	TILE_SEL	BG_MAP	OBJ_SIZE	OBJ_EN	BG_EN
bit 7	6	5	4	3	2	1	bit 0

Register 9.2: 0xFF41 - STAT - PPU status register

U	R/W-0	R/W-0	R/W-0	R/W-0	R-0	R-0	R-0
	INTR_LYC	INTR_M2	INTR_M1	INTR_M0	LYC_STAT	LCD_MODE<1:0>	
bit 7	6	5	4	3	2	1	bit 0

Register 9.3: 0xFF42 - SCY - Vertical scroll register

R/W-0	R/W-0	R/W-0	R/W-0	R/W-0	R/W-0	R/W-0	R/W-0
SCY<7:0>							
bit 7	6	5	4	3	2	1	bit 0

Register 9.4: 0xFF43 - SCX - Horizontal scroll register

R/W-0	R/W-0	R/W-0	R/W-0	R/W-0	R/W-0	R/W-0	R/W-0
SCX<7:0>							
bit 7	6	5	4	3	2	1	bit 0

Register 9.5: 0xFF44 - LY - Scanline register

R-0	R-0	R-0	R-0	R-0	R-0	R-0	R-0
LY<7:0>							
bit 7	6	5	4	3	2	1	bit 0

Register 9.6: 0xFF45 - LYC - Scanline compare register

R/W-0	R/W-0	R/W-0	R/W-0	R/W-0	R/W-0	R/W-0	R/W-0
LYC<7:0>							
bit 7	6	5	4	3	2	1	bit 0

Chapter 10

Port P1 (Joypad, Super Game Boy communication)

Register 10.1: 0xFF00 - P1 - Joypad/Super Game Boy communication register

U	U	W-0	W-0	R-x	R-x	R-x	R-x
		P15	P14	P13	P12	P11	P10
bit 7	6	5	4	3	2	1	bit 0

bit 7-6 Unimplemented: Ignored during writes, reads are undefined

bit 5 P15

bit 4 P14

bit 3 P13

bit 2 P12

bit 1 P11

bit 0 P10

Chapter 11

Serial communication

Register 11.1: 0xFF01 - SB - Serial data register

R/W-0	R/W-0	R/W-0	R/W-0	R/W-0	R/W-0	R/W-0	R/W-0
SB<7:0>							
bit 7	6	5	4	3	2	1	bit 0

bit 7-0 **SB<7:0>**: Serial data

Register 11.2: 0xFF02 - SC - Serial control register

R/W-0	U	U	U	U	U	U	R/W-0
SIO_EN							SIO_CLK
bit 7	6	5	4	3	2	1	bit 0

bit 7 **SIO_EN**

bit 6-1 **Unimplemented**: Ignored during writes, reads are undefined

bit 0 **SIO_CLK**

Part IV

Game Boy game cartridges

Chapter 12

MBC1 mapper chip

The majority of games for the original Game Boy use the MBC1 chip. MBC1 supports ROM sizes up to 16 Mbit (128 banks of 0x4000 bytes) and RAM sizes up to 256 Kbit (4 banks of 0x2000 bytes). The information in this section is based on my MBC1 research, Tauwasser's research notes [6], and Pan Docs [7].

12.1 MBC1 registers

i **Caveat**

These registers don't have any standard names and are usually referred to using their address ranges or purposes instead. This document uses names to clarify which register is meant when referring to one.

The MBC1 chip includes four registers that affect the behaviour of the chip. Of the cartridge bus address signals, only A13-A15 are connected to the MBC, so lower address bits don't matter when the CPU is accessing the MBC and all registers are effectively mapped to address ranges instead of single addresses. All registers are smaller than 8 bits, and unused bits are simply ignored during writes. The registers are not directly readable.

Register 12.1: 0x0000-0x1FFF - RAMG - MBC1 RAM gate register

U	U	U	U	W-0	W-0	W-0	W-0
				RAMG<3:0>			
bit 7	6	5	4	3	2	1	bit 0

bit 7-4 Unimplemented: Ignored during writes

bit 3-0 RAMG<3:0>: RAM gate register

0b1010 = enable access to chip RAM

All other values disable access to chip RAM

The RAMG register is used to enable access to the cartridge SRAM if one exists on the cartridge circuit board. RAM access is disabled by default but can be enabled by writing to the 0x0000-0x1FFF address range a value with the bit pattern 0b1010 in the lower nibble. Upper bits don't matter, but any other bit pattern in the lower nibble disables access to RAM.

When RAM access is disabled, all writes to the external RAM area 0xA000-0xBFFF are ignored, and reads return undefined values. Pan Docs recommends disabling RAM when it's not being accessed to protect the contents [7].

Speculation

We don't know the physical implementation of RAMG, but it's certainly possible that the 0b1010 bit pattern check is done at write time and the register actually consists of just a single bit.

Register 12.2: 0x2000–0x3FFF - BANK1 - MBC1 bank register 1

U	U	U	W-0	W-0	W-0	W-0	W-1
			BANK1<4:0>				
bit 7	6	5	4	3	2	1	bit 0

bit 7-5 Unimplemented: Ignored during writes

bit 4-0 BANK1<4:0>: Bank register 1

Never contains the value 0b00000.

If 0b00000 is written, the resulting value will be 0b00001 instead.

The 5-bit BANK1 register is used as the lower 5 bits of the ROM bank number when the CPU accesses the 0x4000–0x7FFF memory area.

MBC1 doesn't allow the BANK1 register to contain zero (bit pattern 0b00000), so the initial value at reset is 0b00001 and attempting to write 0b00000 will write 0b00001 instead. This makes it impossible to read banks 0x00, 0x20, 0x40 and 0x60 from the 0x4000–0x7FFF memory area, because those bank numbers have 0b00000 in the lower bits. Due to the zero value adjustment, requesting any of these banks actually requests the next bank (e.g. 0x21 instead of 0x20).

Register 12.3: 0x2000–0x3FFF - BANK1 - MBC1 bank register 2

U	U	U	U	U	U	W-0	W-0
						BANK2<1:0>	
bit 7	6	5	4	3	2	1	bit 0

bit 7-2 Unimplemented: Ignored during writes

bit 1-0 BANK2<1:0>: Bank register 2

The 2-bit BANK2 register can be used as the upper bits of the ROM bank number, or as the 2-bit RAM bank number. Unlike BANK1, BANK2 doesn't disallow zero, so all 2-bit values are possible.

Register 12.4: 0x6000–0x7FFF - MODE - MBC1 mode register

U	U	U	U	U	U	U	W-0
							MODE
bit 7	6	5	4	3	2	1	bit 0

bit 7-1 Unimplemented: Ignored during writes

bit 0 MODE: Mode register

0b1 = BANK2 affects accesses to 0x0000–0x3FFF, 0x4000–0x7FFF, 0xA000–0xBFFF

0b0 = BANK2 affects only accesses to 0x4000–0x7FFF

The MODE register determines how the BANK2 register value is used during memory accesses.

Warning

Most documentation, including Pan Docs [7], calls value 0b0 ROM banking mode, and value 0b1 RAM banking mode. This terminology reflects the common use cases, but “RAM banking” is slightly misleading because value 0b1 also affects ROM reads in multicart cartridges and cartridges that have a 8 or 16 Mbit ROM chip.

12.2 ROM in the 0x0000–0x7FFF area

In MBC1 cartridges, the A0-A13 cartridge bus signals are connected directly to the corresponding ROM pins, and the remaining ROM pins (A14-A20) are controlled by the MBC1. These remaining pins form the ROM bank number.

When the 0x0000–0x3FFF address range is accessed, the effective bank number depends on the MODE register. In MODE 0b0 the bank number is always 0, but in MODE 0b1 it’s formed by shifting the BANK2 register value left by 5 bits.

When the 0x4000–0x7FFF address range is accessed, the effective bank number is always a combination of BANK1 and BANK2 register values.

If the cartridge ROM is smaller than 16 Mbit, there are less ROM address pins to connect to and therefore some bank number bits are ignored. For example, 4 Mbit ROMs only need a 5-bit bank number, so the BANK2 register value is always ignored because those bits are simply not connected to the ROM.

Accessed address	ROM address bits		
	Bank number	Address within bank	
	20-19	18-14	13-0
0x0000–0x3FFF, MODE = 0b0	0b00	0b00000	A<13:0>
0x0000–0x3FFF, MODE = 0b1	BANK2	0b00000	A<13:0>
0x4000–0x7FFF	BANK2	BANK1	A<13:0>

Table 12.1: Mapping of physical ROM address bits in MBC1 carts

ROM banking example 1

Let’s assume we have previously written 0x12 to the BANK1 register and 0b01 to the BANK2 register. The effective bank number during ROM reads depends on which address range we read and on the value of the MODE register:

Value of the BANK 1 register `0b10010`

Value of the BANK 2 register `0b01`

Effective ROM bank number (reading `0x4000–0x7FFF`) `0b0110010` (= 50 = `0x32`)

Effective ROM bank number (reading `0x0000–0x3FFF`, MODE = `0b0`) `0b0000000` (= 0 = `0x00`)

Effective ROM bank number (reading `0x0000–0x3FFF`, MODE = `0b1`) `0b0100000` (= 32 = `0x20`)

ROM banking example 2

Let's assume we have previously requested ROM bank number 68, MBC1 mode is `0b0`, and we are now reading a byte from `0x72A7`. The actual physical ROM address that will be read is going to be `0x1132A7` and is constructed in the following way:

Value of the BANK 1 register `0b00100`

Value of the BANK 2 register `0b10`

ROM bank number `0b1000100` (= 68 = `0x44`)

Address being read `0b0111 0010 1010 0111` (= `0x72A7`)

Actual physical ROM address `0b1 0001 0011 0010 1010 0111` (= `0x1132A7`)

12.3 RAM in the `0xA000–0xBFFF` area

Some MBC1 carts include SRAM, which is mapped to the `0xA000–0xBFFF` area. If no RAM is present, or RAM is not enabled with the RAMG register, all reads return undefined values and writes have no effect.

On boards that have RAM, the A0-A12 cartridge bus signals are connected directly to the corresponding RAM pins, and pins A13-A14 are controlled by the MBC1. Most of the time the RAM size is 64 Kbit, which corresponds to a single bank of `0x2000` bytes. With larger RAM sizes the BANK2 register value can be used for RAM banking to provide the two high address bits.

In MODE `0b0` the BANK2 register value is not used, so the first RAM bank is always mapped to the `0xA000–0xBFFF` area. In MODE `0b1` the BANK2 register value is used as the bank number.

Accessed address	RAM address bits	
	Bank number	Address within bank
	14-13	12-0
<code>0xA000–0xBFFF</code> , MODE = <code>0b0</code>	<code>0b00</code>	A<12:0>
<code>0xA000–0xBFFF</code> , MODE = <code>0b1</code>	BANK2	A<12:0>

Table 12.2: Mapping of physical RAM address bits in MBC1 carts

RAM banking example 1

Let's assume we have previously written `0b10` to the BANK2 register, MODE is `0b1`, RAMG is `0b1010` and we are now reading a byte from `0xB123`. The actual physical RAM address that will be read is going to be `0x5123` and is constructed in the following way:

Value of the BANK 2 register 0b10

Address being read 0b1011 0001 0010 0011 (= 0xB123)

Actual physical RAM address 0b101 0001 0010 0011 (= 0x5123)

12.4 MBC1 multicarts (“MBC1M”)

MBC1 is also used in a couple of “multicart” cartridges, which include more than one game on the same cartridge. These cartridges use the same regular MBC1 chip, but the circuit board is wired a bit differently. This alternative wiring is sometimes called “MBC1M”, but technically the mapper chip is the same. All known MBC1 multicarts use 8 Mbit ROMs, so there’s no definitive wiring for other ROM sizes.

In MBC1 multicarts bit 4 of the BANK1 register is not physically connected to anything, so it’s skipped. This means that the bank number is actually a 6-bit number. In all known MBC1 multicarts the games reserve 16 banks each, so BANK2 can actually be considered “game number”, while BANK1 is the internal bank number within the selected game. At reset BANK2 is 0b00, and the “game” in this slot is actually a game selection menu. The menu code selects MODE 0b1 and writes the game number to BANK2 once the user selects a game.

From a ROM banking point of view, multicarts simply skip bit 4 of the BANK1 register, but otherwise the behaviour is the same. MODE 0b1 guarantees that all ROM accesses, including accesses to 0x0000–0x3FFF, use the BANK2 register value.

Accessed address	ROM address bits		
	Bank number		Address within bank
	19-18	17-14	13-0
0x0000–0x3FFF, MODE = 0b0	0b00	0b0000	A<13:0>
0x0000–0x3FFF, MODE = 0b1	BANK2	0b0000	A<13:0>
0x4000–0x7FFF	BANK2	BANK1<3:0>	A<13:0>

Table 12.3: Mapping of physical ROM address bits in MBC1 multicarts

ROM banking example 1

Let’s assume we have previously requested “game number” 3 (= 0b11) and ROM bank number 29 (= 0x1D), MBC1 mode is 0b1, and we are now reading a byte from 0x6C15. The actual physical ROM address that will be read is going to be 0xF6C15 and is constructed in the following way:

Value of the BANK 1 register 0b11101

Value of the BANK 2 register 0b11

ROM bank number 0b111101 (= 61 = 0x3D)

Address being read 0b0110 1100 0001 0101 (= 0x6C15)

Actual physical ROM address 0b1111 0110 1100 0001 0101 (= 0xF6C15)

Detecting multicarts

MBC1 multicarts are not detectable by simply looking at the ROM header, because the ROM type value is just one of the normal MBC1 values. However, detection is possible by going through BANK2 values and looking at “bank 0” of each multicart game and doing some heuristics based

on the header data. All the included games, including the game selection menu, have proper header data. One example of a good heuristic is logo data verification.

So, if you have a 8 Mbit cart with MBC1, first assume that it's a multicart and bank numbers are 6-bit values. Set BANK1 to zero and loop through the four possible BANK2 values while checking the data at 0x0104–0x0133. In other words, check logo data starting from physical ROM locations 0x00104, 0x40104, 0x80104, and 0xC0104. If proper logo data exists with most of the BANK2 values, the cart is most likely a multicart. Note that multicarts can just have two actual games, so one of the locations might not have the header data in place.

12.5 Dumping MBC1 carts

MBC1 cartridge dumping is fairly straightforward with the right hardware. The total number of banks is read from the header, and each bank is read one byte at a time. However, BANK1 register zero-adjustment and multicart cartridges need to be considered in ROM dumping code.

Banks 0x20, 0x40 and 0x60 can only be read from the 0x0000–0x3FFF memory area and only when MODE register value is 0b1. Using MODE 0b1 has no undesirable effects when doing ROM dumping, so using it at all times is recommended for simplicity.

Multicarts should be detected using the logo check described earlier, and if a multicart is detected, BANK1 should be considered a 4-bit register in the dumping code.

```
BANK1 = 0x2000
BANK2 = 0x4000
MODE = 0x6000
write_byte(MODE, 0x01)
for bank in range(0, num_banks):
    write_byte(BANK1, bank)
    if is_multicart:
        write_byte(BANK2, bank >> 4)
        bank_start = 0x4000 if bank & 0x0f else 0x0000
    else:
        write_byte(BANK2, bank >> 5)
        bank_start = 0x4000 if bank & 0x1f else 0x0000
    for addr in range(bank_start, bank_start + 0x4000):
        buf += read_byte(addr)
```

Listing 12.1: Python pseudo-code for MBC1 ROM dumping

Chapter 13

MBC2 mapper chip

MBC2 supports ROM sizes up to 2 Mbit (16 banks of 0x4000 bytes) and includes an internal 512x4 bit RAM array, which is its unique feature. The information in this section is based on my MBC2 research, Tauwasser's research notes [8], and Pan Docs [7].

Speculation

MBC1 is strictly more powerful than MBC2 because it supports more ROM and RAM. This raises a very important question: why does MBC2 exist? It's possible that Nintendo tried to integrate a small amount of RAM on the MBC chip for cost reasons, but it seems that this didn't work out very well since all later MBCs revert this design decision and use separate RAM chips.

13.1 MBC2 registers

Caveat

These registers don't have any standard names and are usually referred to using one of their addresses or purposes instead. This document uses names to clarify which register is meant when referring to one.

The MBC2 chip includes two registers that affect the behaviour of the chip. The registers are mapped a bit differently compared to other MBCs. Both registers are accessible within 0x0000-0x3FFF, and within that range, the register is chosen based on the A8 address signal. In practice, this means that the registers are mapped to memory in an alternating pattern. For example, 0x0000, 0x2000 and 0x3000 are RAMG, and 0x0100, 0x2100 and 0x3100 are ROMB. Both registers are smaller than 8 bits, and unused bits are simply ignored during writes. The registers are not directly readable.

Register 13.1: 0x0000-0x3FFF when A8=0b0 - RAMG - MBC2 RAM gate register

U	U	U	U	W-0	W-0	W-0	W-0
				RAMG<3:0>			
bit 7	6	5	4	3	2	1	bit 0

bit 7-4 Unimplemented: Ignored during writes

bit 3-0 RAMG<3:0>: RAM gate register

0b1010 = enable access to chip RAM

All other values disable access to chip RAM

The 4-bit MBC2 RAMG register works in a similar manner as MBC1 RAMG, so the upper bits don't matter and only the bit pattern 0b1010 enables access to RAM.

When RAM access is disabled, all writes to the external RAM area $0xA000-0xBFFF$ are ignored, and reads return undefined values. Pan Docs recommends disabling RAM when it's not being accessed to protect the contents [7].

Speculation

We don't know the physical implementation of RAMG, but it's certainly possible that the $0b1010$ bit pattern check is done at write time and the register actually consists of just a single bit.

Register 13.2: $0x0000-0x3FFF$ when $A8=0b1$ - ROMB - MBC2 ROM bank register

U	U	U	U	W-0	W-0	W-0	W-1
				ROMB<3:0>			
bit 7	6	5	4	3	2	1	bit 0

bit 3-0 ROMB<3:0>: ROM bank register

Never contains the value $0b0000$.

If $0b0000$ is written, the resulting value will be $0b0001$ instead.

The 4-bit ROMB register is used as the ROM bank number when the CPU accesses the $0x4000-0x7FFF$ memory area.

Like MBC1 BANK1, the MBC2 ROMB register doesn't allow zero (bit pattern $0b0000$) in the register, so any attempt to write $0b0000$ writes $0b0001$ instead.

13.2 ROM in the $0x0000-0x7FFF$ area

In MBC2 cartridges, the A0-A13 cartridge bus signals are connected directly to the corresponding ROM pins, and the remaining ROM pins (A14-A17) are controlled by the MBC2. These remaining pins form the ROM bank number.

When the $0x0000-0x3FFF$ address range is accessed, the effective bank number is always 0.

When the $0x4000-0x7FFF$ address range is accessed, the effective bank number is the current ROMB register value.

Accessed address	ROM address bits	
	Bank number	Address within bank
	17-14	13-0
$0x0000-0x3FFF$	$0b0000$	$A<13:0>$
$0x4000-0x7FFF$	ROMB	$A<13:0>$

Table 13.1: Mapping of physical ROM address bits in MBC2 carts

13.3 RAM in the $0xA000-0xBFFF$ area

All MBC2 carts include SRAM, because it is located directly inside the MBC2 chip. These cartridges never use a separate RAM chip, but battery backup circuitry and a battery are optional. If RAM is not enabled with the RAMG register, all reads return undefined values and writes have no effect.

MBC2 RAM is only 4-bit RAM, so the upper 4 bits of data do not physically exist in the chip. When writing to it, the upper 4 bits are ignored. When reading from it, the upper 4 data signals are not driven by the chip, so their content is undefined and should not be relied on.

MBC2 RAM consists of 512 addresses, so only A0-A8 matter when accessing the RAM region. There is no banking, and the `0xA000-0xBFFF` area is larger than the RAM, so the addresses wrap around. For example, accessing `0xA000` is the same as accessing `0xA200`, so it is possible to write to the former address and later read the written data using the latter address.

Accessed address	RAM address bits
	8-0
<code>0xA000-0xBFFF</code>	<code>A<8:0></code>

Table 13.2: Mapping of physical RAM address bits in MBC2 carts

13.4 Dumping MBC2 carts

MBC2 cartridges are very simple to dump. The total number of banks is read from the header, and each bank is read one byte at a time. ROMB zero adjustment must be considered in the ROM dumping code, but this only means that bank 0 should be read from `0x0000-0x3FFF` and not from `0x4000-0x7FFF` like other banks.

```
ROMB = 0x2100
for bank in range(0, num_banks):
    write_byte(ROMB, bank)
    bank_start = 0x4000 if bank > 0 else 0x0000
    for addr in range(bank_start, bank_start + 0x4000):
        buf += read_byte(addr)
```

Listing 13.2: Python pseudo-code for MBC2 ROM dumping

Chapter 14

MBC3 mapper chip

MBC3 supports ROM sizes up to 16 Mbit (128 banks of $0x4000$ bytes), and RAM sizes up to 256 Kbit (4 banks of $0x2000$ bytes). It also includes a real-time clock (RTC) that can be clocked with a quartz crystal on the cartridge even when the Game Boy is powered down. The information in this section is based on my MBC3 research, and Pan Docs [7].

Chapter 15

MBC30 mapper chip

MBC30 is a variant of MBC3 used by Japanese Pokemon Crystal to support a larger ROM chip and a larger RAM chip. Featurewise MBC30 is almost identical to MBC3, but supports ROM sizes up to 32 Mbit (256 banks of `0x4000` bytes), and RAM sizes up to 512 Kbit (8 banks of `0x2000` bytes). Information in this section is based on my MBC30 research.

⚠ Warning

The circuit board of Japanese Pokemon Crystal includes a 1 Mbit RAM chip, but MBC30 is limited to 512 Kbit RAM. One of the RAM address pins is unused, so half of the RAM is wasted and is inaccessible without modifications. So, the game only uses 512 Kbit and there is a mismatch between accessible and the physical amounts of RAM.

Chapter 16

MBC5 mapper chip

The majority of games for Game Boy Color use the MBC5 chip. MBC5 supports ROM sizes up to 64 Mbit (512 banks of 0x4000 bytes), and RAM sizes up to 1 Mbit (16 banks of 0x2000 bytes). The information in this section is based on my MBC5 research, and The Cycle-Accurate Game Boy Docs [9].

16.1 MBC5 registers

Register 16.1: 0x0000–0x1FFF - RAMG - MBC5 RAM gate register

W-0	W-0	W-0	W-0	W-0	W-0	W-0	W-0
RAMG<7:0>							
bit 7	6	5	4	3	2	1	bit 0

bit 7-0 RAMG<7:0>: RAM gate register

0b00001010 = enable access to cartridge RAM

All other values disable access to cartridge RAM

The 8-bit MBC5 RAMG register works in a similar manner as MBC1 RAMG, but it is a full 8-bit register so upper bits matter when writing to it. Only 0b00001010 enables RAM access, and all other values (including 0b10001010 for example) disable access to RAM.

When RAM access is disabled, all writes to the external RAM area 0xA000–0xBFFF are ignored, and reads return undefined values. Pan Docs recommends disabling RAM when it's not being accessed to protect the contents [7].

Speculation

We don't know the physical implementation of RAMG, but it's certainly possible that the 0b00001010 bit pattern check is done at write time and the register actually consists of just a single bit.

Register 16.2: 0x2000–0x2FFF - ROMB0 - MBC5 lower ROM bank register

W-0	W-0	W-0	W-0	W-0	W-0	W-0	W-1
ROMB0<7:0>							
bit 7	6	5	4	3	2	1	bit 0

bit 7-0 ROMB0<7:0>: Lower ROM bank register

The 8-bit ROMB0 register is used as the lower 8 bits of the ROM bank number when the CPU accesses the 0x4000–0x7FFF memory area.

Register 16.3: 0x3000–0x3FFF - ROMB1 - MBC5 upper ROM bank register

U	U	U	U	U	U	U	W-0
							ROMB1
bit 7	6	5	4	3	2	1	bit 0

bit 7-1 Unimplemented: Ignored during writes

bit 0 ROMB1: Upper ROM bank register

The 1-bit ROMB1 register is used as the most significant bit (bit 9) of the ROM bank number when the CPU accesses the 0x4000–0x7FFF memory area.

Register 16.4: 0x4000–0x5FFF - RAMB - MBC5 RAM bank register

U	U	U	U	W-0	W-0	W-0	W-0
				RAMB<3:0>			
bit 7	6	5	4	3	2	1	bit 0

bit 7-4 Unimplemented: Ignored during writes

bit 3-0 RAMB<3:0>: RAM bank register

The 4-bit RAMB register is used as the RAM bank number when the CPU accesses the 0x–A000–0xBFFF memory area.

Chapter 17

MBC6 mapper chip

MBC6 supports ROM sizes up to 16 Mbit (256 banks of $0x2000$ bytes), and RAM sizes up to 4 Mbit (128 banks of $0x1000$ bytes). The information in this section is based on my MBC6 research.

Chapter 18

MBC7

TODO.

Chapter 19

HuC-1 mapper chip

HuC-1 supports ROM sizes up to 8 Mbit (64 banks of 0x4000 bytes), and RAM sizes up to 256 Kbit (4 banks of 0x2000 bytes). It also includes a sensor and a LED for infrared communication. The information in this section is based on my HuC-1 research.

Chapter 20

HuC-3 mapper chip

HuC-3 supports ROM sizes up to 16 Mbit (128 banks of 0x4000 bytes), and RAM sizes up to 1 Mbit (16 banks of 0x2000 bytes). Like HuC-1, it includes support for infrared communication, but also includes a real-time-clock (RTC) and output pins used to control a piezoelectric buzzer. The information in this section is based on my HuC-3 research.

Chapter 21

MMM01

TODO.

Chapter 22

TAMA5

TODO.

Appendices

Appendix A

Instruction set tables

These tables include all the opcodes in the Sharp SM83 instruction set. The style and layout of these tables was inspired by the opcode tables available at pastraiser.com [10].

	x0	x1	x2	x3	x4	x5	x6	x7	x8	x9	xa	xb	xc	xd	xe	xf
0x	NOP	LD BC,nn	LD (BC),A	INC BC	INC B	DEC B	LD B,n	RLCA	LD (nn),SP	ADD HL,BC	LD A,(BC)	DEC BC	INC C	DEC C	LD C,n	RRCA
1x	STOP	LD DE,nn	LD (DE),A	INC DE	INC D	DEC D	LD D,n	RLA	JR e	ADD HL,DE	LD A,(DE)	DEC DE	INC E	DEC E	LD E,n	RRA
2x	JR NZ,e	LD HL,nn	LD (HL+),A	INC HL	INC H	DEC H	LD H,n	DAA	JR Z,e	ADD HL,HL	LD A,(HL+)	DEC HL	INC L	DEC L	LD L,n	CPL
3x	JR NC,e	LD SP,nn	LD (HL-),A	INC SP	INC (HL)	DEC (HL)	LD (HL),n	SCF	JR C,e	ADD HL,SP	LD A,(HL-)	DEC SP	INC A	DEC A	LD A,n	CCF
4x	LD B,B	LD B,C	LD B,D	LD B,E	LD B,H	LD B,L	LD B,(HL)	LD B,A	LD C,B	LD C,C	LD C,D	LD C,E	LD C,H	LD C,L	LD C,(HL)	LD C,A
5x	LD D,B	LD D,C	LD D,D	LD D,E	LD D,H	LD D,L	LD D,(HL)	LD D,A	LD E,B	LD E,C	LD E,D	LD E,E	LD E,H	LD E,L	LD E,(HL)	LD E,A
6x	LD H,B	LD H,C	LD H,D	LD H,E	LD H,H	LD H,L	LD H,(HL)	LD H,A	LD L,B	LD L,C	LD L,D	LD L,E	LD L,H	LD L,L	LD L,(HL)	LD L,A
7x	LD (HL),B	LD (HL),C	LD (HL),D	LD (HL),E	LD (HL),H	LD (HL),L	HALT	LD (HL),A	LD A,B	LD A,C	LD A,D	LD A,E	LD A,H	LD A,L	LD A,(HL)	LD A,A
8x	ADD B	ADD C	ADD D	ADD E	ADD H	ADD L	ADD (HL)	ADD A	ADC B	ADC C	ADC D	ADC E	ADC H	ADC L	ADC (HL)	ADC A
9x	SUB B	SUB C	SUB D	SUB E	SUB H	SUB L	SUB (HL)	SUB A	SBC B	SBC C	SBC D	SBC E	SBC H	SBC L	SBC (HL)	SBC A
ax	AND B	AND C	AND D	AND E	AND H	AND L	AND (HL)	AND A	XOR B	XOR C	XOR D	XOR E	XOR H	XOR L	XOR (HL)	XOR A
bx	OR B	OR C	OR D	OR E	OR H	OR L	OR (HL)	OR A	CP B	CP C	CP D	CP E	CP H	CP L	CP (HL)	CP A
cx	RET NZ	POP BC	JP NZ,nn	JP nn	CALL NZ,nn	PUSH BC	ADD n	RST 0x00	RET	RET	JP Z,nn	CB op	CALL Z,nn	CALL nn	ADC n	RST 0x08
dx	RET NC	POP DE	JP NC,nn	-	CALL NC,nn	PUSH DE	SUB n	RST 0x10	RET C	RETI	JP C,nn	-	CALL C,nn	-	SBC n	RST 0x18
ex	LDH (n),A	POP HL	LDH (C),A	-	-	PUSH HL	AND n	RST 0x20	ADD SP,e	JP HL	LD (nn),A	-	-	-	XOR n	RST 0x28
fx	LDH A,(n)	POP AF	LDH A,(C)	DI	-	PUSH AF	OR n	RST 0x30	LD HL,SP+e	LD SP,HL	LD A,(nn)	EI	-	-	CP n	RST 0x38

Table A.1: Sharp SM83 instruction set

Legend:

8-bit loads	16-bit loads	8-bit arithmetic/logical	16-bit arithmetic	Rotates, shifts, and bit operations	Control flow	Miscellaneous
Undefined						

- n** unsigned 8-bit immediate data
- nn** unsigned 16-bit immediate data
- e** signed 8-bit immediate data

	x0	x1	x2	x3	x4	x5	x6	x7	x8	x9	xa	xb	xc	xd	xe	xf
0x	RLC B	RLC C	RLC D	RLC E	RLC H	RLC L	RLC (HL)	RLC A	RRC B	RRC C	RRC D	RRC E	RRC H	RRC L	RRC (HL)	RRC A
1x	RL B	RL C	RL D	RL E	RL H	RL L	RL (HL)	RL A	RR B	RR C	RR D	RR E	RR H	RR L	RR (HL)	RR A
2x	SLA B	SLA C	SLA D	SLA E	SLA H	SLA L	SLA (HL)	SLA A	SRA B	SRA C	SRA D	SRA E	SRA H	SRA L	SRA (HL)	SRA A
3x	SWAP B	SWAP C	SWAP D	SWAP E	SWAP H	SWAP L	SWAP (HL)	SWAP A	SRL B	SRL C	SRL D	SRL E	SRL H	SRL L	SRL (HL)	SRL A
4x	BIT 0,B	BIT 0,C	BIT 0,D	BIT 0,E	BIT 0,H	BIT 0,L	BIT 0,(HL)	BIT 0,A	BIT 1,B	BIT 1,C	BIT 1,D	BIT 1,E	BIT 1,H	BIT 1,L	BIT 1,(HL)	BIT 1,A
5x	BIT 2,B	BIT 2,C	BIT 2,D	BIT 2,E	BIT 2,H	BIT 2,L	BIT 2,(HL)	BIT 2,A	BIT 3,B	BIT 3,C	BIT 3,D	BIT 3,E	BIT 3,H	BIT 3,L	BIT 3,(HL)	BIT 3,A
6x	BIT 4,B	BIT 4,C	BIT 4,D	BIT 4,E	BIT 4,H	BIT 4,L	BIT 4,(HL)	BIT 4,A	BIT 5,B	BIT 5,C	BIT 5,D	BIT 5,E	BIT 5,H	BIT 5,L	BIT 5,(HL)	BIT 5,A
7x	BIT 6,B	BIT 6,C	BIT 6,D	BIT 6,E	BIT 6,H	BIT 6,L	BIT 6,(HL)	BIT 6,A	BIT 7,B	BIT 7,C	BIT 7,D	BIT 7,E	BIT 7,H	BIT 7,L	BIT 7,(HL)	BIT 7,A
8x	RES 0,B	RES 0,C	RES 0,D	RES 0,E	RES 0,H	RES 0,L	RES 0,(HL)	RES 0,A	RES 1,B	RES 1,C	RES 1,D	RES 1,E	RES 1,H	RES 1,L	RES 1,(HL)	RES 1,A
9x	RES 2,B	RES 2,C	RES 2,D	RES 2,E	RES 2,H	RES 2,L	RES 2,(HL)	RES 2,A	RES 3,B	RES 3,C	RES 3,D	RES 3,E	RES 3,H	RES 3,L	RES 3,(HL)	RES 3,A
ax	RES 4,B	RES 4,C	RES 4,D	RES 4,E	RES 4,H	RES 4,L	RES 4,(HL)	RES 4,A	RES 5,B	RES 5,C	RES 5,D	RES 5,E	RES 5,H	RES 5,L	RES 5,(HL)	RES 5,A
bx	RES 6,B	RES 6,C	RES 6,D	RES 6,E	RES 6,H	RES 6,L	RES 6,(HL)	RES 6,A	RES 7,B	RES 7,C	RES 7,D	RES 7,E	RES 7,H	RES 7,L	RES 7,(HL)	RES 7,A
cx	SET 0,B	SET 0,C	SET 0,D	SET 0,E	SET 0,H	SET 0,L	SET 0,(HL)	SET 0,A	SET 1,B	SET 1,C	SET 1,D	SET 1,E	SET 1,H	SET 1,L	SET 1,(HL)	SET 1,A
dx	SET 2,B	SET 2,C	SET 2,D	SET 2,E	SET 2,H	SET 2,L	SET 2,(HL)	SET 2,A	SET 3,B	SET 3,C	SET 3,D	SET 3,E	SET 3,H	SET 3,L	SET 3,(HL)	SET 3,A
ex	SET 4,B	SET 4,C	SET 4,D	SET 4,E	SET 4,H	SET 4,L	SET 4,(HL)	SET 4,A	SET 5,B	SET 5,C	SET 5,D	SET 5,E	SET 5,H	SET 5,L	SET 5,(HL)	SET 5,A
fx	SET 6,B	SET 6,C	SET 6,D	SET 6,E	SET 6,H	SET 6,L	SET 6,(HL)	SET 6,A	SET 7,B	SET 7,C	SET 7,D	SET 7,E	SET 7,H	SET 7,L	SET 7,(HL)	SET 7,A

Table A.2: Sharp SM83 CB-prefixed instructions

Appendix B

Memory map tables

	bit 7	6	5	4	3	2	1	bit 0
0xFF00 P1			P15 buttons	P14 d-pad	P13 start	P12 select	P11 B	P10 A
0xFF01 SB	SB<7:0>							
0xFF02 SC	SIO_EN						SIO_FAST	SIO_CLK
0xFF03								
0xFF04 DIV	DIVH<7:0>							
0xFF05 TIMA	TIMA<7:0>							
0xFF06 TMA	TMA<7:0>							
0xFF07 TAC						TAC_EN	TAC_CLK<1:0>	
0xFF08								
0xFF09								
0xFF0A								
0xFF0B								
0xFF0C								
0xFF0D								
0xFF0E								
0xFF0F IF				IF_JOYPAD	IF_SERIAL	IF_TIMER	IF_STAT	IF_VBLANK
0xFF10 NR10								
0xFF11 NR11								
0xFF12 NR12								
0xFF13 NR13								
0xFF14 NR14								
0xFF15								
0xFF16 NR21								
0xFF17 NR22								
0xFF18 NR23								
0xFF19 NR24								
0xFF1A NR30								
0xFF1B NR31								
0xFF1C NR32								
0xFF1D NR33								
0xFF1E NR34								
0xFF1F								
	bit 7	6	5	4	3	2	1	bit 0

Table B.3: 0xFFxx registers: 0xFF00–0xFF1F

	bit 7	6	5	4	3	2	1	bit 0
0xFF20 NR41								
0xFF21 NR42								
0xFF22 NR43								
0xFF23 NR44								
0xFF24 NR50								
0xFF25 NR51								
0xFF26 NR52								
0xFF27								
0xFF28								
0xFF29								
0xFF2A								
0xFF2B								
0xFF2C								
0xFF2D								
0xFF2E								
0xFF2F								
0xFF30 WAV00								
0xFF31 WAV01								
0xFF32 WAV02								
0xFF33 WAV03								
0xFF34 WAV04								
0xFF35 WAV05								
0xFF36 WAV06								
0xFF37 WAV07								
0xFF38 WAV08								
0xFF39 WAV09								
0xFF3A WAV10								
0xFF3B WAV11								
0xFF3C WAV12								
0xFF3D WAV13								
0xFF3E WAV14								
0xFF3F WAV15								
	bit 7	6	5	4	3	2	1	bit 0

Table B.4: 0xFFxx registers: 0xFF20–0xFF3F

	bit 7	6	5	4	3	2	1	bit 0
0xFF40 LCDC	LCD_EN	WIN_MAP	WIN_EN	TILE_SEL	BG_MAP	OBJ_SIZE	OBJ_EN	BG_EN
0xFF41 STAT		INTR_LYC	INTR_M2	INTR_M1	INTR_M0	LYC_STAT	LCD_MODE<1:0>	
0xFF42 SCY								
0xFF43 SCX								
0xFF44 LY								
0xFF45 LYC								
0xFF46 DMA	DMA<7:0>							
0xFF47 BGP								
0xFF48 OBPO								
0xFF49 OBP1								
0xFF4A WY								
0xFF4B WX								
0xFF4C ????								
0xFF4D KEY1	KEY1_FAST							KEY1_EN
0xFF4E								
0xFF4F VBK							VBK<1:0>	
0xFF50 BOOT								BOOT_OFF
0xFF51 HDMA1								
0xFF52 HDMA2								
0xFF53 HDMA3								
0xFF54 HDMA4								
0xFF55 HDMA5								
0xFF56 RP								
0xFF57								
0xFF58								
0xFF59								
0xFF5A								
0xFF5B								
0xFF5C								
0xFF5D								
0xFF5E								
0xFF5F								
	bit 7	6	5	4	3	2	1	bit 0

Table B.5: 0xFFxx registers: 0xFF40–0xFF5F

	bit 7	6	5	4	3	2	1	bit 0
0xFF60 ????								
0xFF61								
0xFF62								
0xFF63								
0xFF64								
0xFF65								
0xFF66								
0xFF67								
0xFF68 BCPS								
0xFF69 BPCD								
0xFF6A OCPS								
0xFF6B OCPD								
0xFF6C ????								
0xFF6D								
0xFF6E								
0xFF6F								
0xFF70 SVBK							SVBK<1:0>	
0xFF71								
0xFF72 ????								
0xFF73 ????								
0xFF74 ????								
0xFF75 ????								
0xFF76 PCM12		PCM12_CH2			PCM12_CH1			
0xFF77 PCM34		PCM34_CH4			PCM34_CH3			
0xFF78								
0xFF79								
0xFF7A								
0xFF7B								
0xFF7C								
0xFF7D								
0xFF7E								
0xFF7F								
0xFFFF IE	IE_UNUSED<2:0>			IE_JOYPAD	IE_SERIAL	IE_TIMER	IE_STAT	IE_VBLANK
	bit 7	6	5	4	3	2	1	bit 0

Table B.6: 0xFFxx registers: 0xFF60–0xFF7F, 0xFFFF

Appendix C

Game Boy external bus

C.1 Bus timings

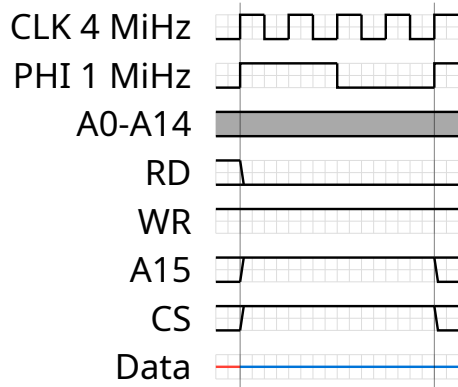
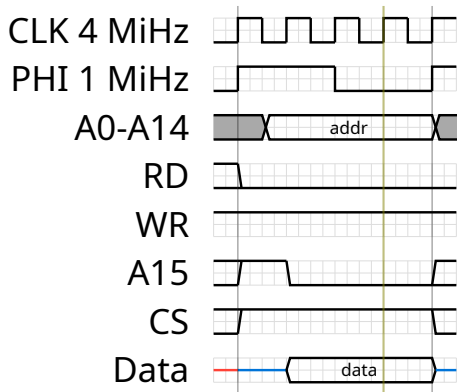
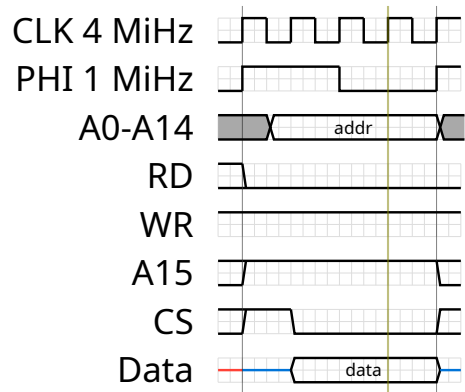

Figure C.5: External bus idle machine cycle



a) $0x0000-0x7FFF^1$



b) $0xA000-0xFDFF$

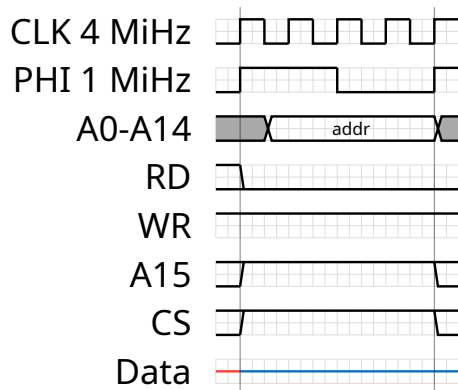

c) $0xFE00-0xFFFF$

Figure C.6: External bus CPU read machine cycles

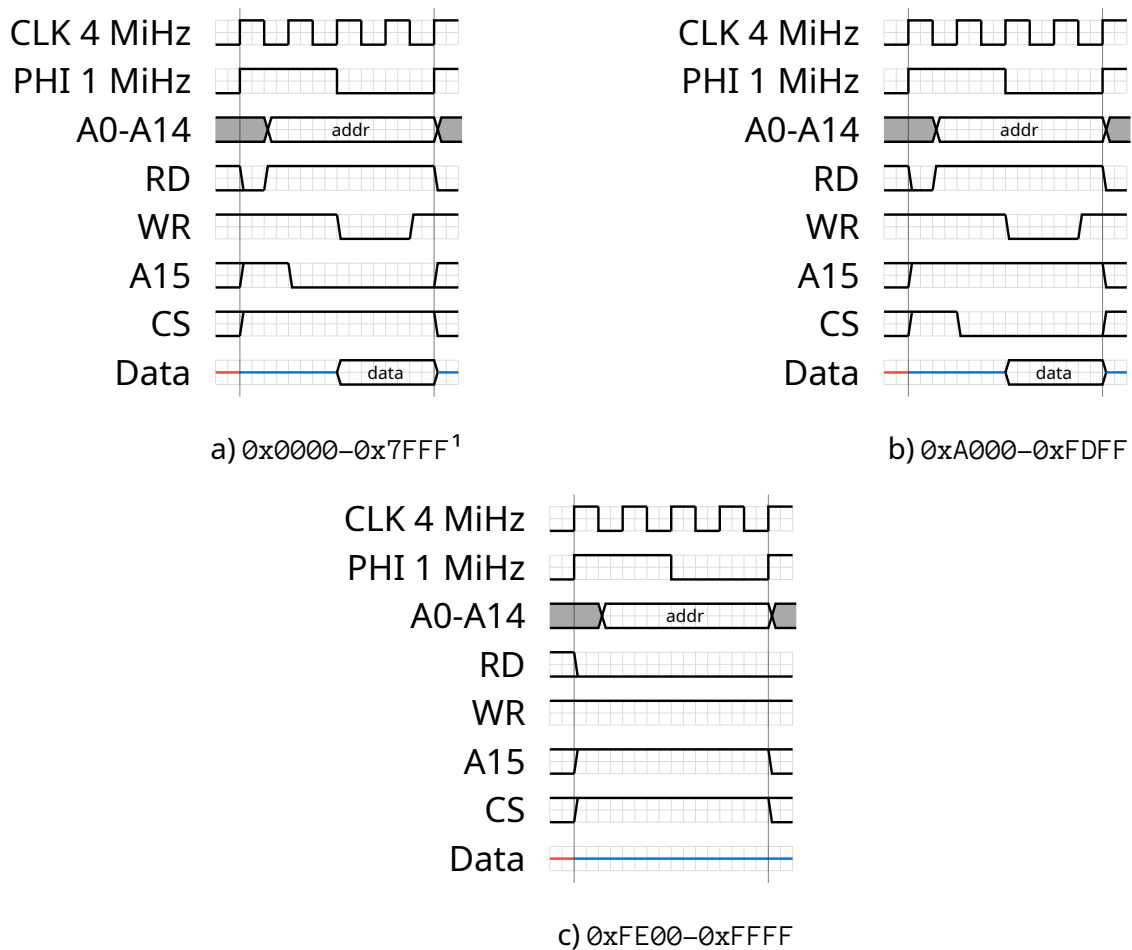

Figure C.7: External bus CPU write machine cycles

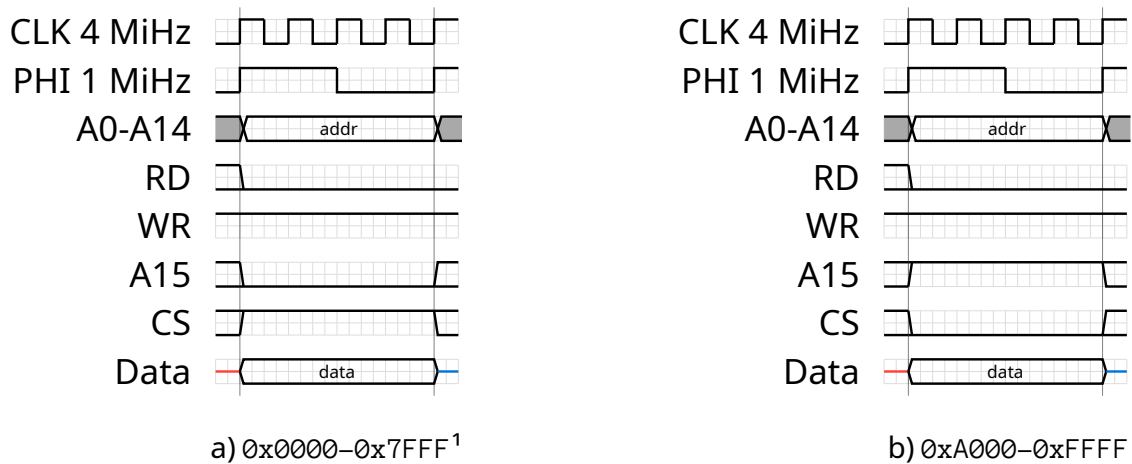

Figure C.8: External bus timings for OAM DMA read machine cycles

¹Does not apply to $0x0000-0x00FF$ accesses while the boot ROM is enabled. Boot ROM accesses do not affect the external bus, so it is in the idle state.

Bibliography

- [1] "Microcomputers Data Book (1990)." Sharp Corporation. [Online]. Available: https://archive.org/details/bitsavers_sharpdataBomputersDataBook_31076011
- [2] "Microcomputer Data Book (1996)." Sharp Corporation. [Online]. Available: https://archive.org/details/bitsavers_sharpdataBomputerDataBook_13840187
- [3] "SM8311/SM8313/SM8314/SM8315 - 8-Bit Single-Chip Microcomputers (Controllers For Home Appliances)." Sharp Corporation.
- [4] Costis Sideris, "The quest for dumping GameBoy Boot ROMs!" [Online]. Available: http://www.its.caltech.edu/~costis/sgb_hack/
- [5] gekkio, "Dumping the Super Game Boy 2 boot ROM." [Online]. Available: <https://gekkio.fi/blog/2015/dumping-the-super-game-boy-2-boot-rom/>
- [6] Tauwasser, "MBC1 - Tauwasser's Wiki." [Online]. Available: <https://wiki.tauwasser.eu/view/MBC1>
- [7] Pan of ATX, M. Fayzullin, P. Felber, P. Robson, and M. Korth, "Pan Docs - Everything You Always Wanted To Know About GAMEBOY." [Online]. Available: <http://bgb.bircd.org/pandocs.htm>
- [8] Tauwasser, "MBC2 - Tauwasser's Wiki." [Online]. Available: <https://wiki.tauwasser.eu/view/MBC2>
- [9] Antonio Niño Díaz (AntonioND), "The Cycle-Accurate Game Boy Docs." [Online]. Available: <https://github.com/AntonioND/giibiiadvance/tree/master/docs>
- [10] "Gameboy CPU (LR35902) instruction set." [Online]. Available: http://www.pastraiser.com/cpu/gameboy/gameboy_opcodes.html